

NON-SHORTING

SCHEMATIC

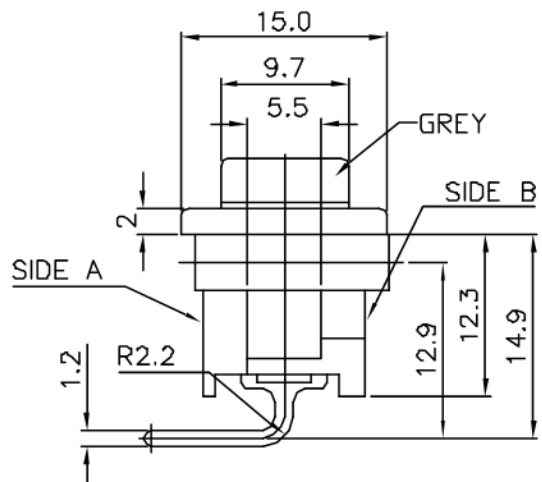

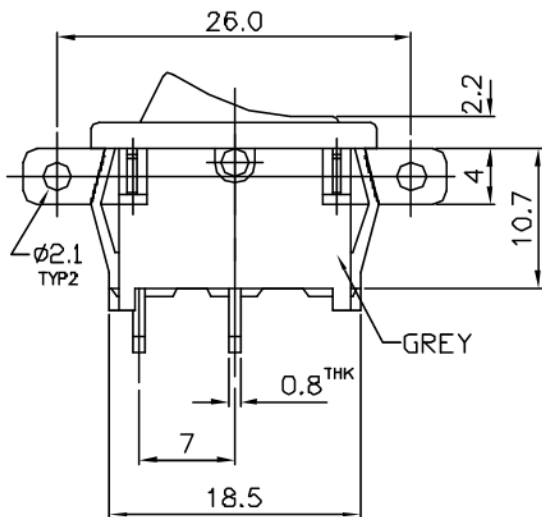

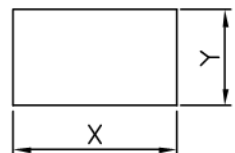

Panel Cut-out Dimensions



Panel Thickness (mm/inch)	DIM X ^{+0.1} (mm/inch)	DIM Y ^{±0.1} (mm/inch)
0.5~1.2 (.02~.047)	19.4 (.764)	13.1 (.516)
1.2~2.0 (.047~.08)	19.7 (.775)	
2.0~3.0 (.08~.118)	20.0 (.787)	

REMARK:

SIDE A :  US ARK-LES
401 90 11A 125VAC
 5.5A 250VAC
 3 2 1

SIDE B :    CE
U11E4
4A 250V~

Customer's No.: ARK-78-6885

ISSUED	SPECIFICATION (INITIAL)	TITLE:	ROCKER SWITCH 1P1T		
	RATING: AC 125V 11A ; AC 250V 5.5A	MODEL NO:	U11WR-11N17-R1(2W)F-F-00-#581		
	CONTACT RESISTANCE: MAX. 30mΩ	UNIT:	mm	DWN	YANG
	INSULATION RESISTANCE: 500MΩ at 500V DC	SCALE:	2 : 1	CHK'D	08/04/06
	WITHSTAND VOLTAGE: AC 1000V for 1 min	TOLERANCE:	±0.2	APPD.	
	OPERATION FORCE: 450±250g				
	SWITCHING LIFE: 10,000 Cycles(6-10c/m loading)				
BY:	 广东科斯达电子科技有限公司 GUANG DONG KE SI DA ELECTRONIC TECHNOLOGY CO., LTD.	DRWG NO:	A50635-04		
DATE:					