

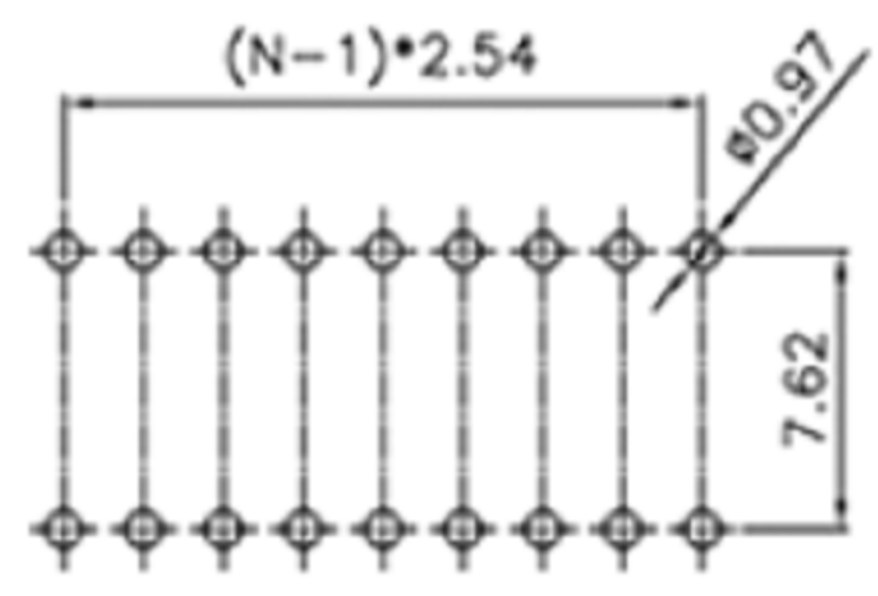

DS Type

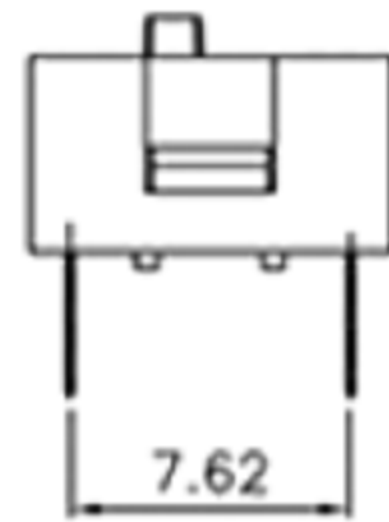
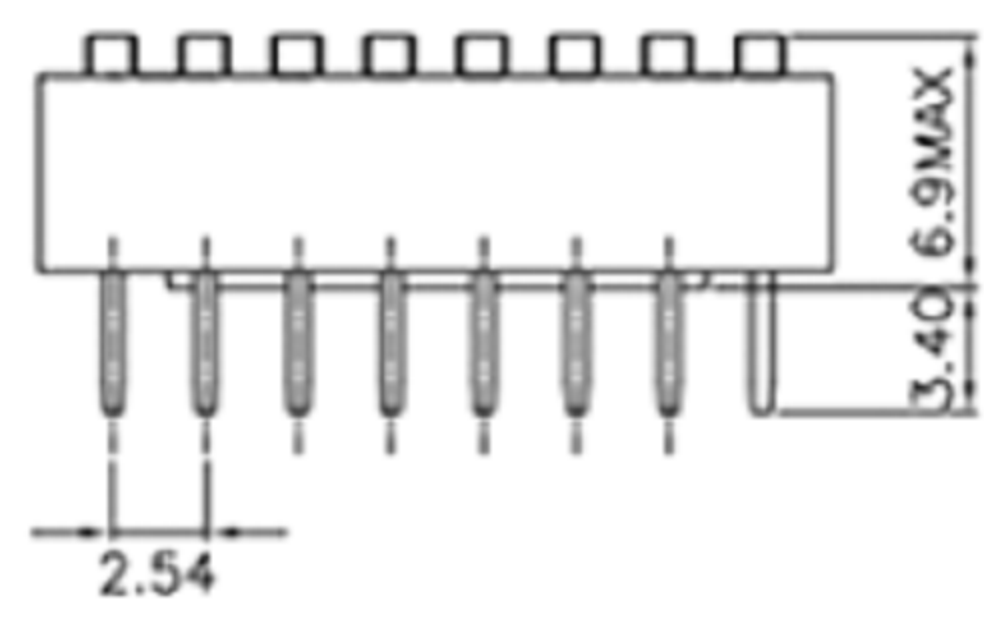
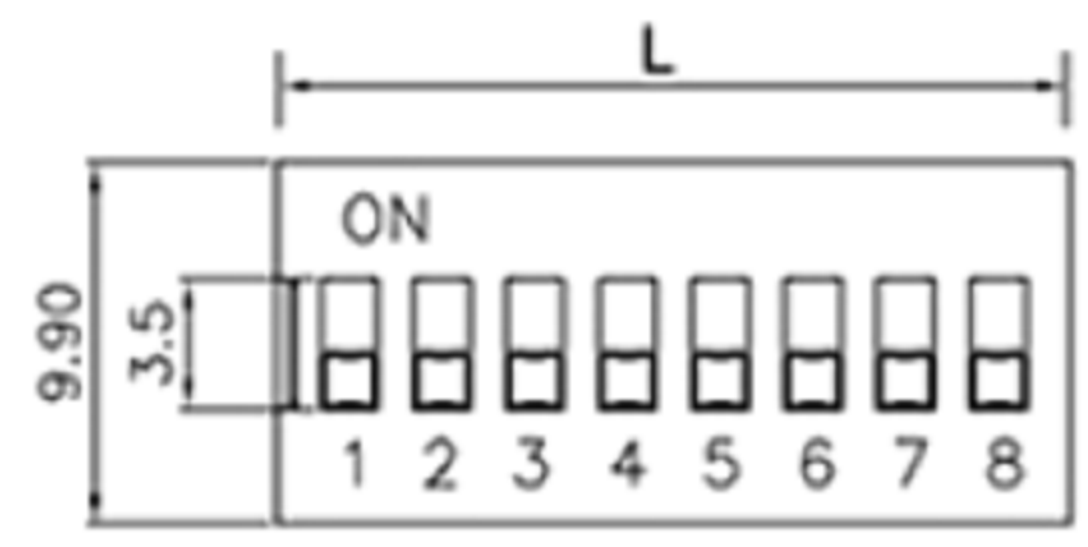

PCB LAYOUT

DA Type

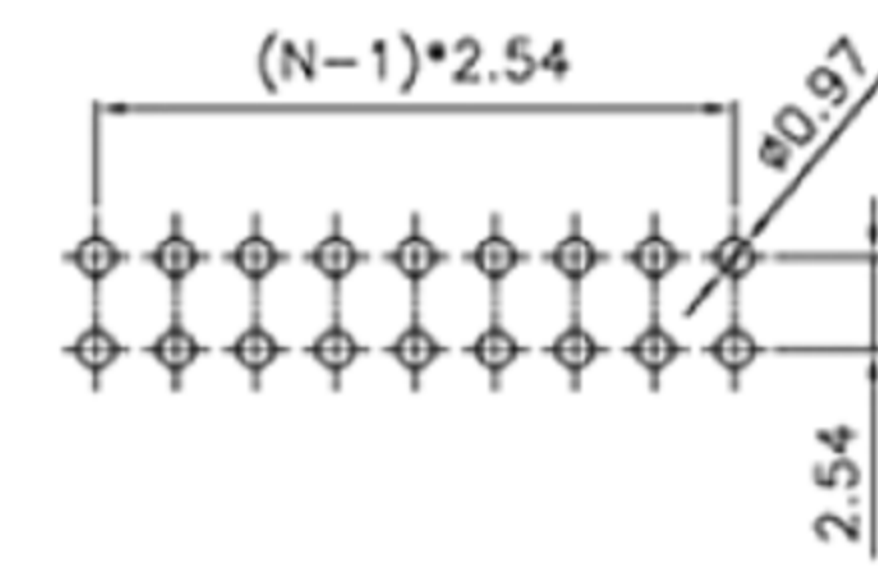
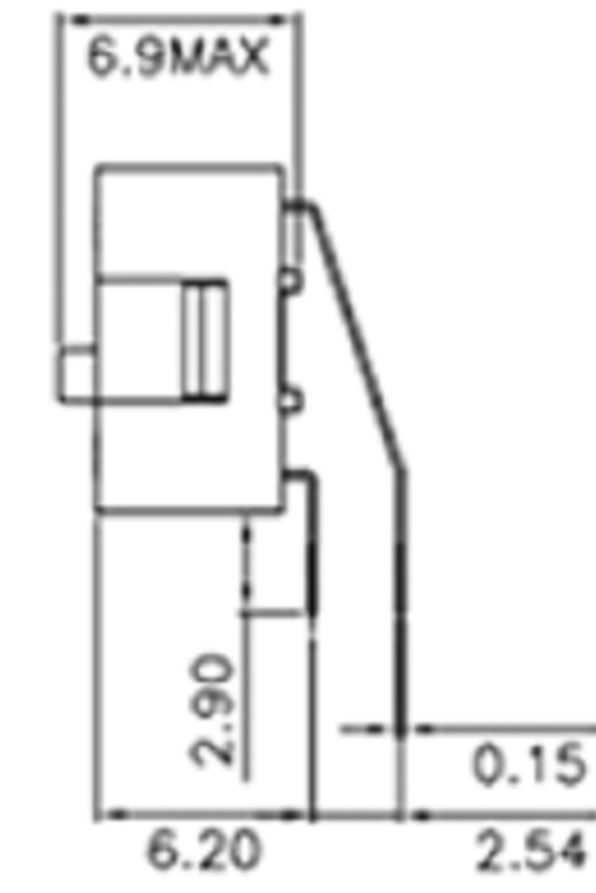
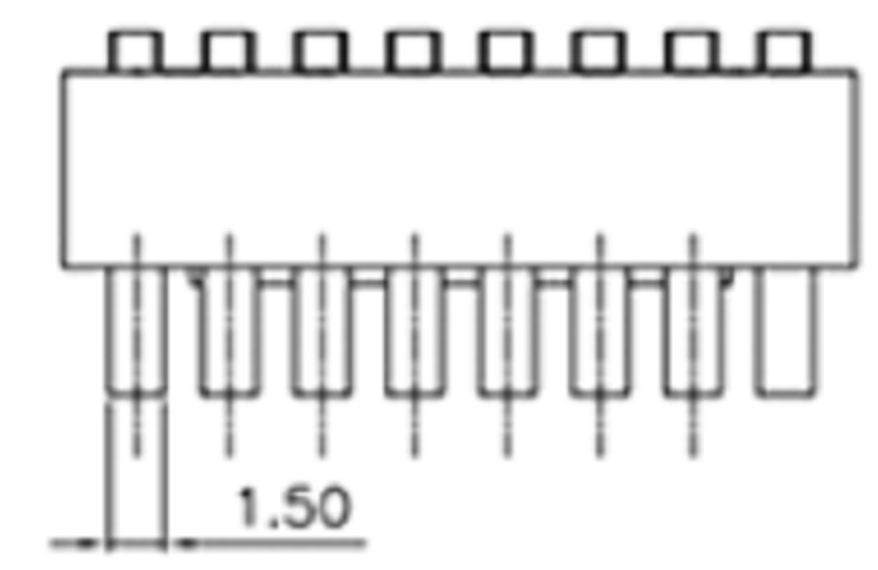
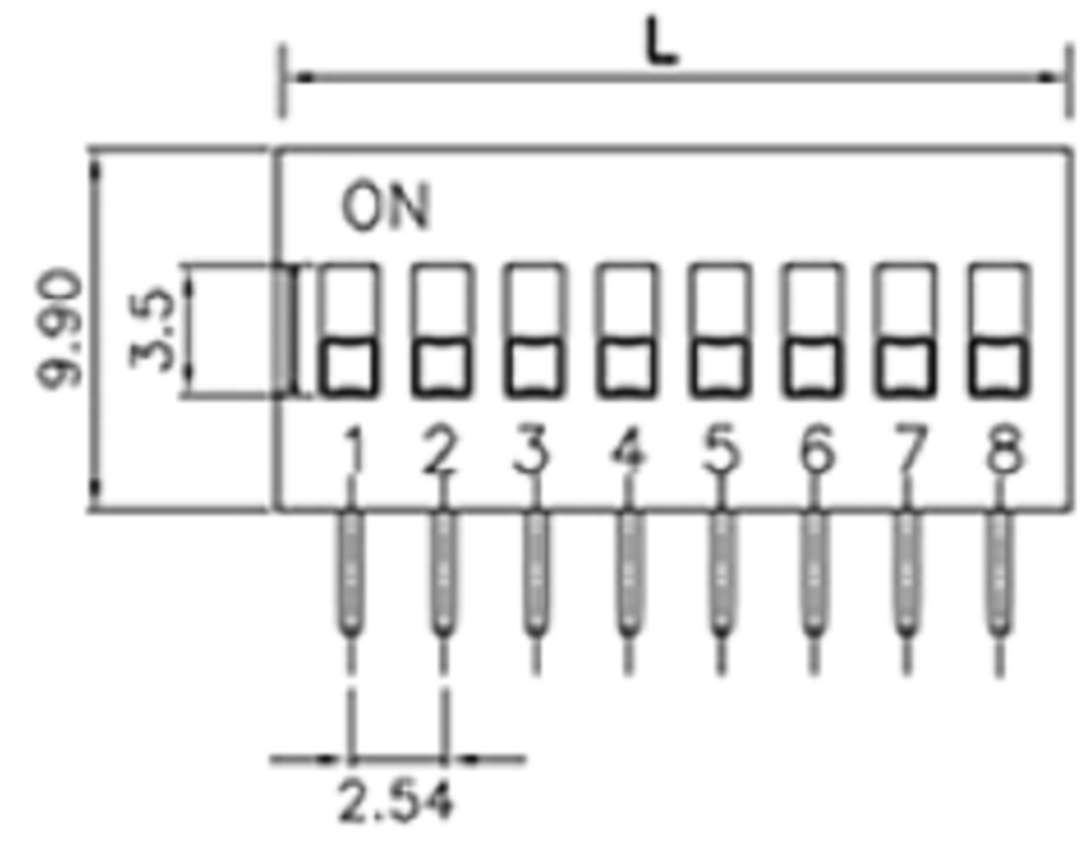

PCB LAYOUT

DP Type

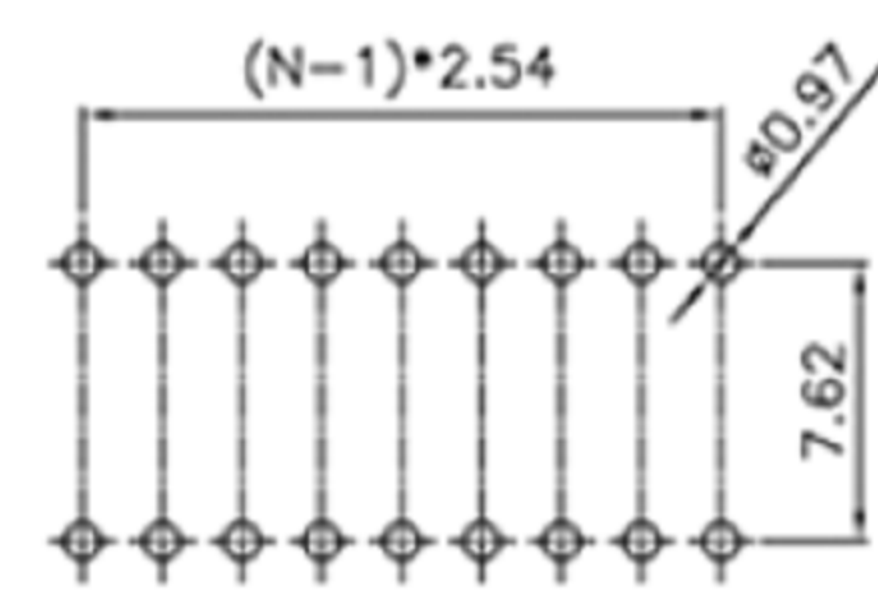
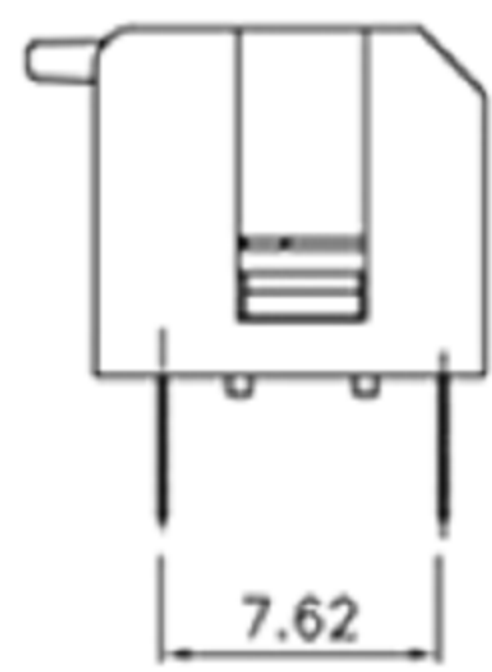
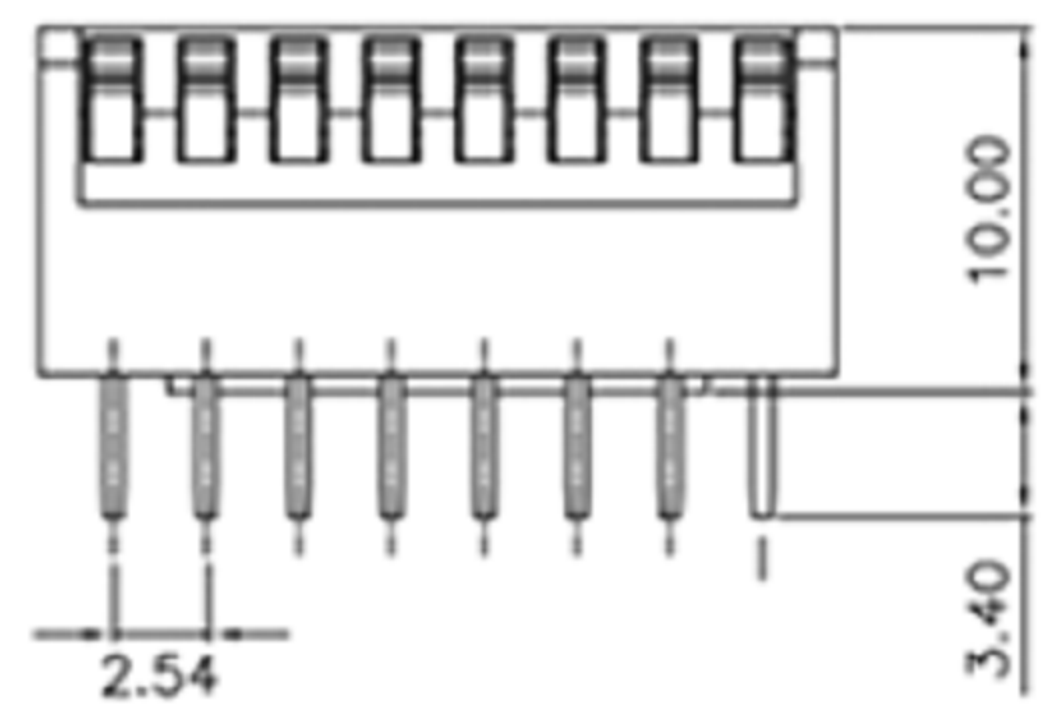
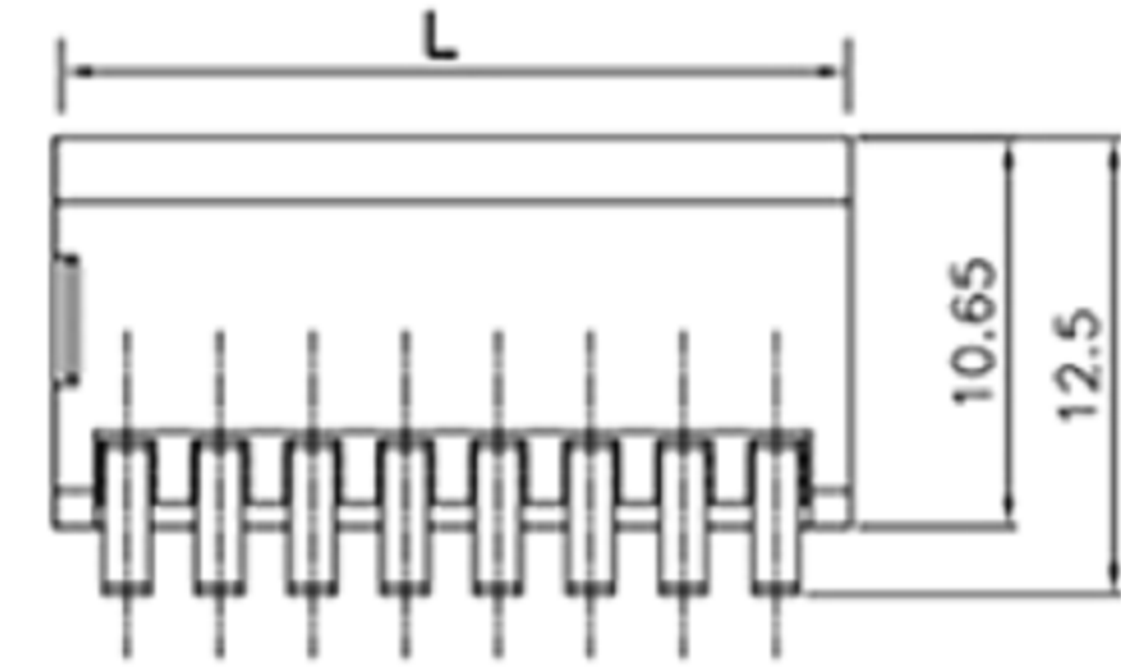

PCB LAYOUT

广东科斯达电子科技有限公司
GUANG DONG KE SI DA ELECTRONIC TECHNOLOGY CO., LTD.

TOLERANCE UNLESS OTHERWISE STATED:	Up to 5 ±0.2	Above 5 ~ 15 ±0.3	Above 15 ~ 30 ±0.4	Above 30 ~ 50 ±0.5	Angle ±0.3	3RD. ANGEL'S	UNITS	MM
------------------------------------	--------------	-------------------	--------------------	--------------------	------------	--------------	-------	----

DRAWN BY:	DATE	MAT'L	TITLE	SWITCH
Jack Lu	12/27/22		MODLE	TACT SWITCH WITH LED
CHECKED BY:	DATE	FINISH	DWG NO.	
Jacky Chen	12/27/22		PART NO.	
APPROVED BY:	DATE	SCALE	1 : 1	
Tony Kao	12/27/22	SHEET NO.	1 of 1	

ITEM NO.	DESCRIPTION	DRAWN	DATE

SIZE	A4
VER	R