

RoHS Compliant

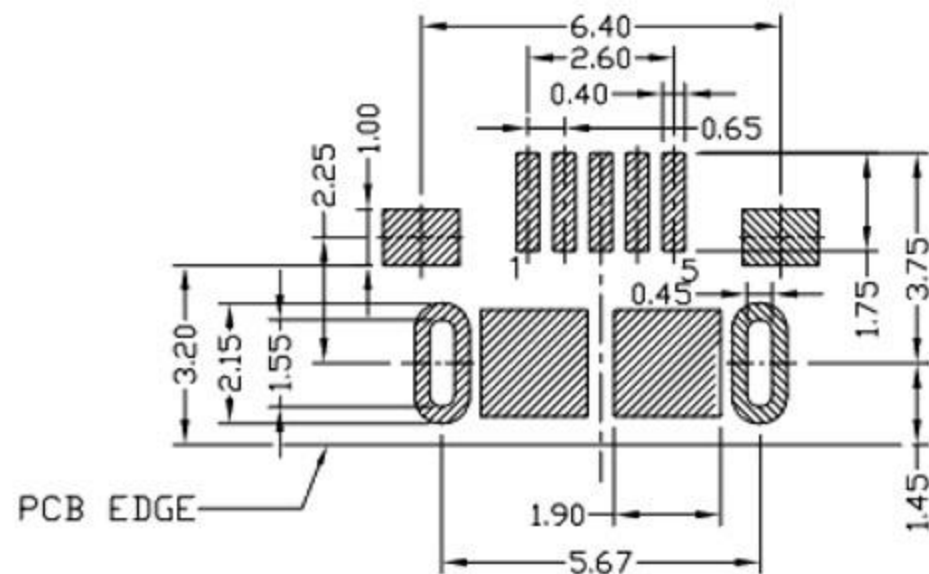
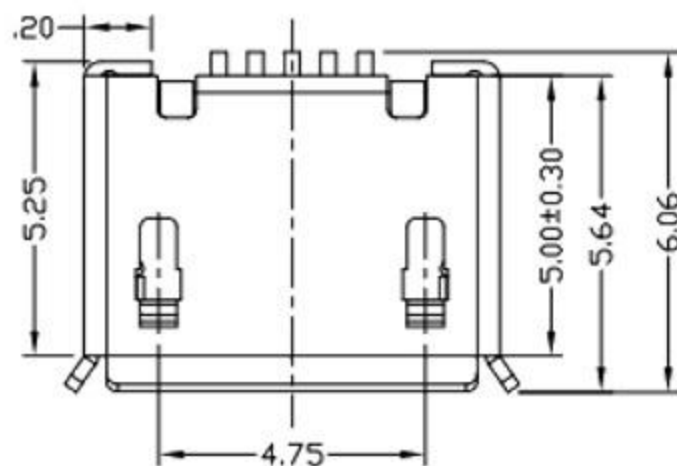
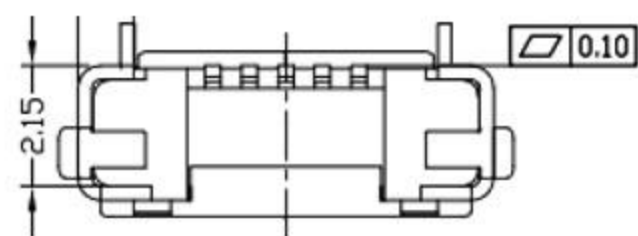
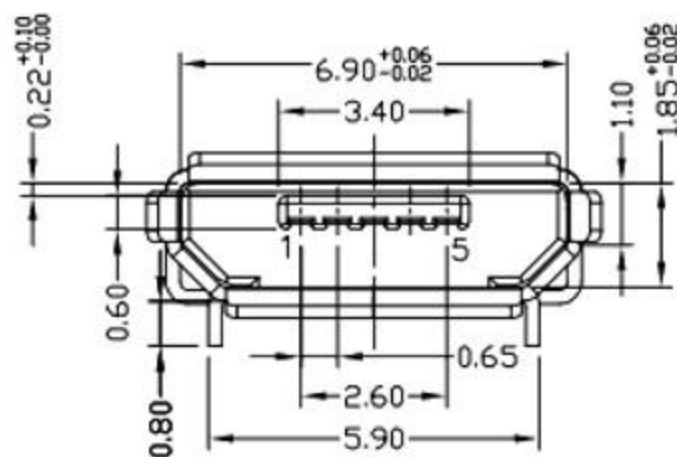
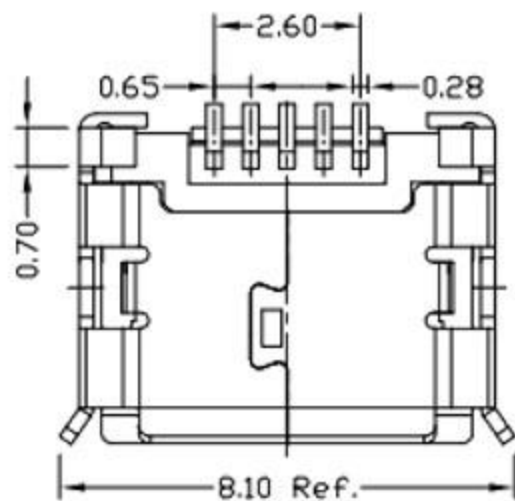
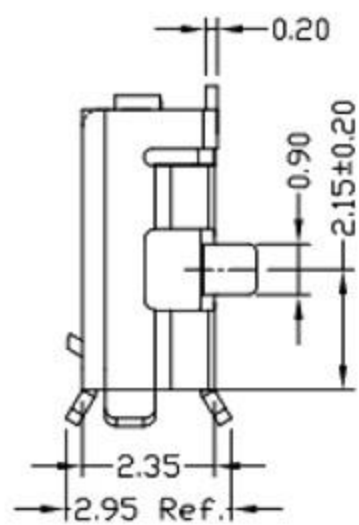

RECOMMENDED PCB LAYOUT

NOTES:

- ELECTRICAL:
 - VOLTAGE CURRENT RATING: PIN1&5 1.8AMP MAX / PIN2&3&4 1AMP MAX. ,30V AC;
 - INSULATION RESISTANCE: 100MΩ MIN;
 - CONTACT RESISTANCE: 30mΩ MAX;
 - WITHSTANDING VOLTAGE: 100V AC; FOR 1 MIN.
 - OPERATING TEMPERATURE: -30°C TO +80°C.
- Mechanical:
 - Mating Force: 35N MAX
 - Unmating Force: 10N MIN.
- DIMENSIONS MARKED "▼" TO BE CHECKED BY Q.C & IPQC.

4.PART NO.

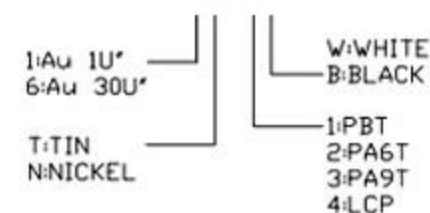

⑤	MID PLATE	1	STAINLESS STEEL	Au . PLATING.	T=0.15mm
④	SHELL	1	STAINLESS STEEL	Au . PLATING.	T=0.30mm
③	TERMINAL-B	1	TABLE 2:	TABLE 2:	T=0.12mm
②	TERMINAL-A	1	TABLE 2:	TABLE 2:	T=0.12mm
①	INSULATOR	1	HIGH TEMP	Black	
NO.	PART NAME	QTY	MATERIAL	DESCRIPTION	REMARK

UNLESS OTHERWISE, GENERAL TOLERANCE:

- X.xxx ±0.10
- X.xx ±0.20
- X.x ±0.30
- X. ±0.38

ANGULAR:

- X.xx ±1°
- X.x ±3°
- X. ±5°

廣東斯柯達電子科技有限公司

TITLE: USB connector P/N: Detail See PART NO. LIST
MODEL:
DRAW NO.:

THIRD ANGLE PROJECTION UNIT: mm SCALE: 1:1 SIZE: A4 SHEET: 1/1

JH2016-080	X2	隨工程图上升版本次	2016.06.15	陈少兵	DESIGN	陈少兵	2016.06.15
JH2016-071	X1	新增规格	2016.06.10	陈少兵	CHECK	郑小伟	2016.06.15
20151224001	X	NEW DRAWING	2016.05.05	陈少兵	APPROVAL	吕海涛	2016.06.15
ECN NO.	REV.	DESCRIPTION	DATE	CHANGE	APPROVAL		