

RoHS Compliant

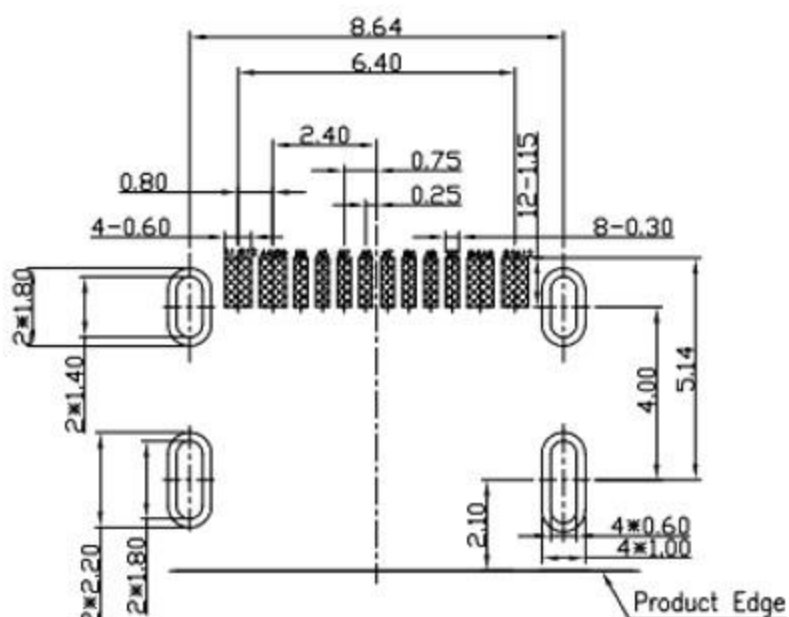
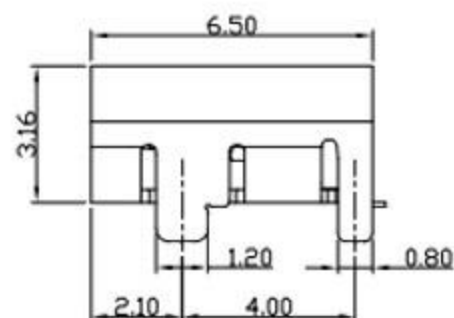
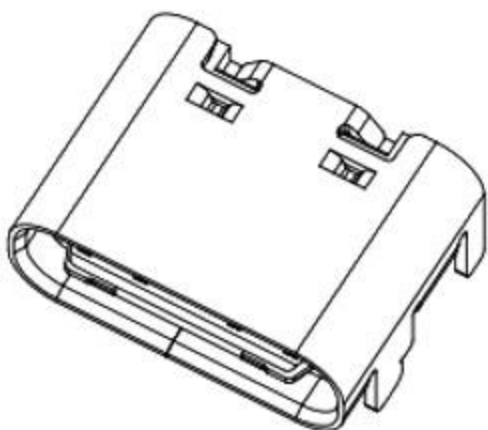
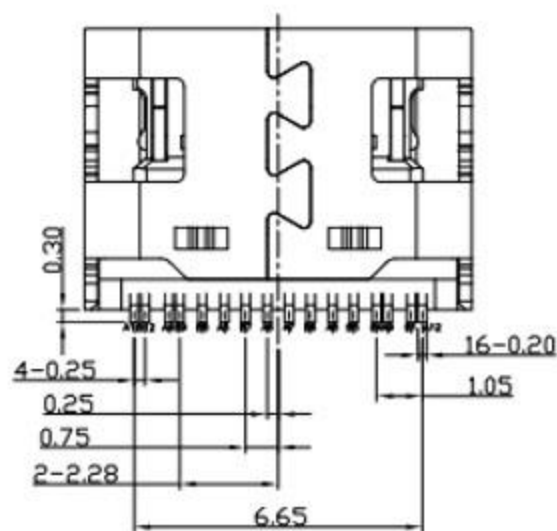
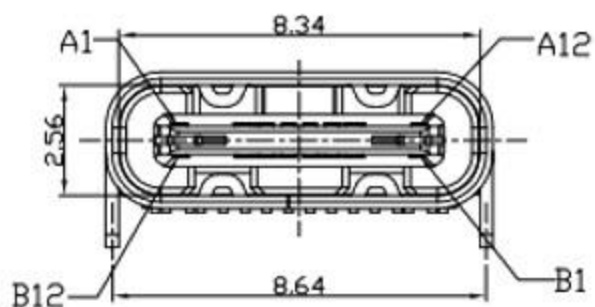
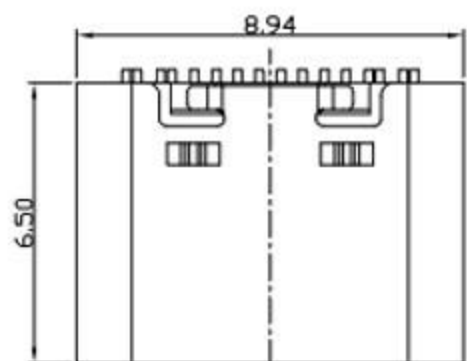
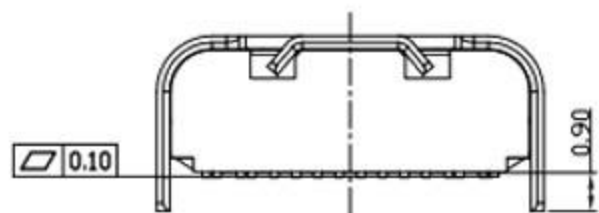

RECOMMENDED P.C.B. LAYOUT
TOLERANCE UNSPECIFIED ±0.05mm

NOTES:

1. ELECTRICAL:

- 1) CURRENT RATING: 3AMP MAX;
- 2) INSULATION RESISTANCE: 100MΩ MIN;
- 3) CONTACT RESISTANCE: 40mΩ MAX;
- 4) WITHSTANDING VOLTAGE: 100V AC;
- 5) OPERATING TEMPERATURE: -30°C TO +85°C.

2. Mechanical:

- 1) Mating Force: 5N~20N
- 2) Unmating Force: 8N~20N
- 3) Durability: 10,000 cycles

3. DIMENSIONS MARKED "▼"
TO BE CHECKED BY Q.C & IPQC.

4. PART NO.



| | | | |
|-----|-------------|-----|-------------|
| A1 | GND | B12 | GND |
| A4 | VBUS | B9 | VBUS |
| A5 | CC1 | B8 | SBU2 |
| A6 | DP1 | B7 | DN2 |
| A7 | DN1 | B6 | DP2 |
| A8 | SBU1 | B5 | CC2 |
| A9 | VBUS | B4 | VBUS |
| A12 | GND | B1 | GND |
| PIN | SIGNAL NAME | PIN | SIGNAL NAME |

| | | | | | |
|-----|------------|-----|-----------------|---------------|----------|
| ⑤ | MID PLATE | 1 | STAINLESS STEEL | Au . PLATING. | T=0.15mm |
| ④ | SHELL | 1 | STAINLESS STEEL | Au . PLATING. | T=0.30mm |
| ③ | TERMINAL-B | 1 | TABLE 2: | TABLE 2: | T=0.12mm |
| ② | TERMINAL-A | 1 | TABLE 2: | TABLE 2: | T=0.12mm |
| ① | INSULATOR | 1 | HIGH TEMP | Black | |
| NO. | PART NAME | QTY | MATERIAL | DESCRIPTION | REMARK |

UNLESS OTHERWISE,
GENERAL TOLERANCE:

- X.xxx ±0.10
- X.xx ±0.20
- X.x ±0.30
- X. ±0.38

ANGULAR:

- X.xx ±1°
- X.x ±3°
- X. ±5°

廣東科斯達電子科技有限公司

| | |
|-------------------------|-------------------------------|
| TITLE: USB connector | P/N: Detail See PART NO. LIST |
| MODEL: | DRAW NO.: |
| THIRD ANGLE PROJECTION | UNIT: mm |
| SCALE: 1:1 | SIZE: A4 |
| SHEET: 1/1 | |

| | | | | | | | |
|-------------|------|-------------|------------|--------|----------|-----|------------|
| JH2016-080 | X2 | 隨工程图上升版本次 | 2016.06.15 | 陈少兵 | DESIGN | 陈少兵 | 2016.06.15 |
| JH2016-071 | X1 | 新增规格 | 2016.06.10 | 陈少兵 | CHECK | 郑小伟 | 2016.06.15 |
| 20151224001 | X | NEW DRAWING | 2016.05.05 | 陈少兵 | APPROVAL | 吕海涛 | 2016.06.15 |
| ECN NO. | REV. | DESCRIPTION | DATE | CHANGE | | | |