

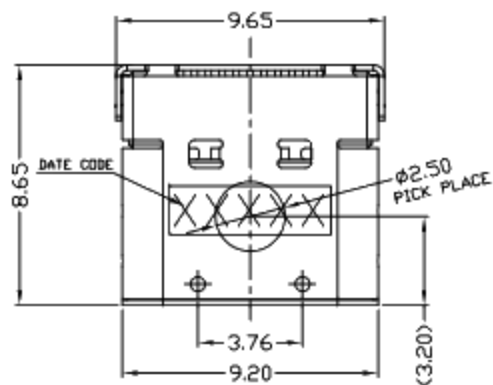

RoHS
Compliant
2002/95/EC

REV.	ECN.	NO.	APPD.



Pin	Signal Name	Mating Sequence	Pin	Signal Name	Mating Sequence
A1	GND	First	B12	GND	First
A2	SSTXp1	Second	B11	SSRXp1	Second
A3	SSTXn1	Second	B10	SSRXn1	Second
A4	V _{CC}	First	B9	V _{CC}	First
A5	CC1	Second	B8	SBU2	Second
A6	Dp1	Second	B7	Dn2	Second
A7	Dn1	Second	B6	Dp2	Second
A8	SBU1	Second	B5	CC2	Second
A9	V _{CC}	First	B4	V _{CC}	First
A10	SSRXn2	Second	B3	SSTXn2	Second
A11	SSRXp2	Second	B2	SSTXp2	Second
A12	GND	First	B1	GND	First
SHELL	GND		SHELL	GND	

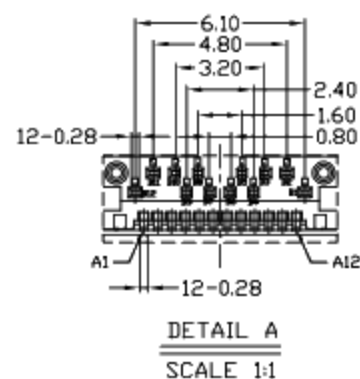
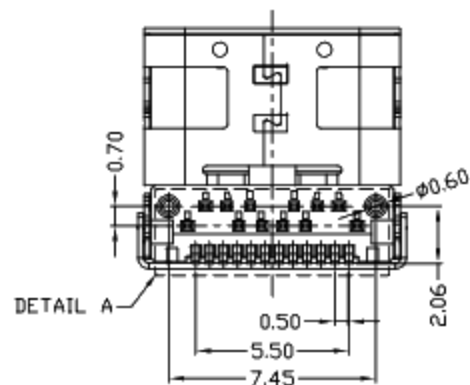
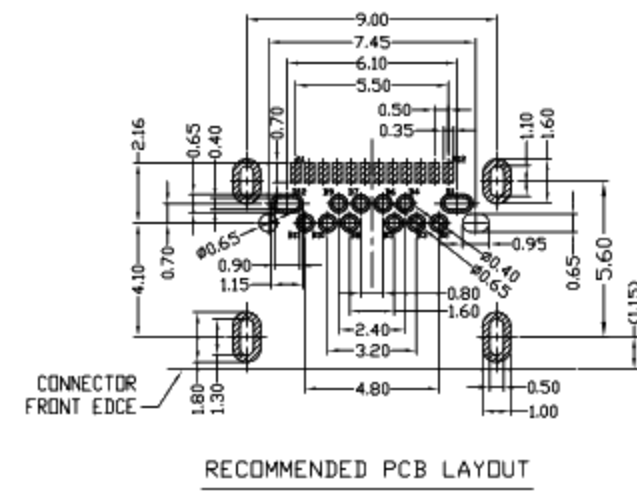
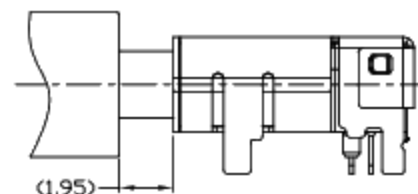
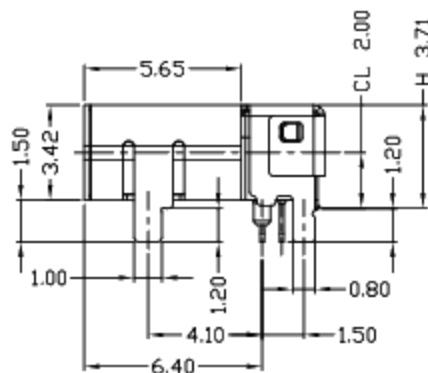
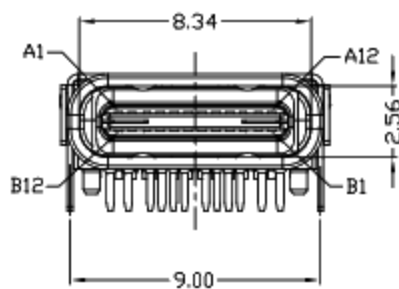

NOTES:

- ELECTRICAL:**
 - CURRENT RATING: 5AMP FOR V_{BUS} PIN; 1.25A FOR V_{CONN} PIN.
 - INSULATION RESISTANCE: 100MΩMIN;
 - CONTACT RESISTANCE: 40mΩMAX;
 - WITHSTANDING VOLTAGE: 100V AC;
 - OPERATING TEMPERATURE: -40°C TO +85°C.
- Mechanical:**
 - Mating Force: 5~20N.
 - Unmating Force: 8~20N AFTER TEST
- DIMENSIONS MARKED "▼" TO BE CHECKED BY Q.C & IPQC.**

4. PART NO.

1Au 1U'
2Au 3U'
5Au 15U'
6Au 30U'

W: WHITE
B: BLACK
1PBT
2PA6T
3PA9T
4LCP

Bill of materials:

NO	PARTS	MATERIAL	QTY	FINISHING
5	SHRAPNEL	STAINLESS STEEL	1	PLATED NICKEL
4	HOOK	STAINLESS STEEL	2	PLATED NICKEL
3	SHELL	STAINLESS STEEL	1	PLATED NICKEL
2	TERMINAL	COPPER ALLOY	24	PLATED GOLD/TIN
1	HOUSING	LCP+30%GF	1	UL94V-0

X.	X' ±2'	UNITS	mm
.X ±0.35	.X' ±2'	MAT'L	SEE NOTE
.XX ±0.3	.XX' ±1'	FINISH	SEE NOTE
.XXX ±0.25	.XXX'	Q'TY	
.XXX ±0.15	.XXX'		

THESE DRAWINGS AND SPECIFICATIONS ARE THE PROPERTY OF ACCURATE INNOVATECH INC. AND SHALL NOT BE REPRODUCED, COPIED OR USED IN ANY MANNER WITHOUT THE PRIOR WRITTEN CONSENT OF ACCURATE INNOVATECH INC.

UNITS	mm
MAT'L	SEE NOTE
FINISH	SEE NOTE
Q'TY	

廣東科斯達電子科技有限公司

TITLE:	PART NO.:			
DR: gan 2015/11/25	DWG NO.:			
CHKD: gan 2015/11/25	SCALE	SHEET	REV.	CUSTOMER DRAWING
APPD:	1:1	1/1	B	