

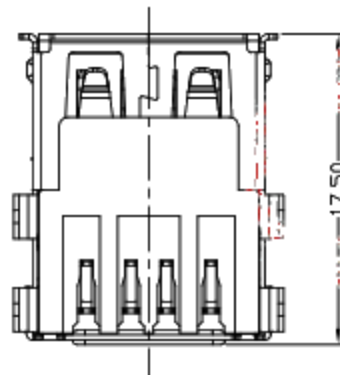

RoHS  
Compliant  
2002/95/EC

REV.	ECN. NO.	APPD.

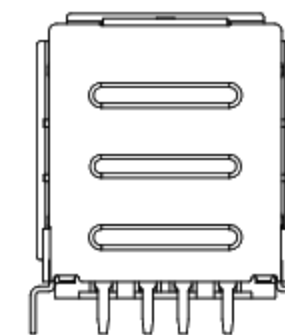
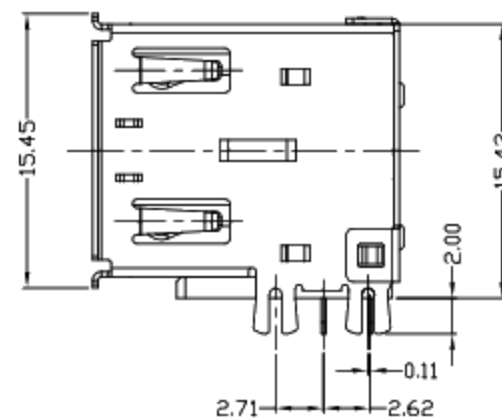
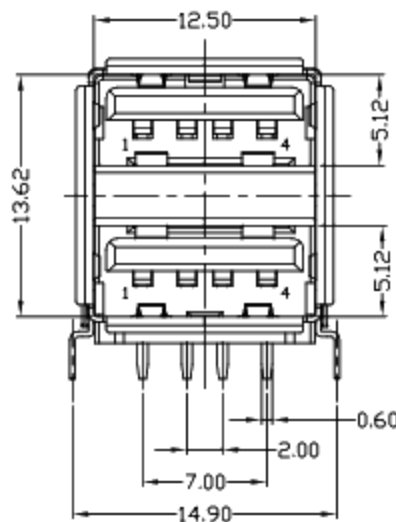
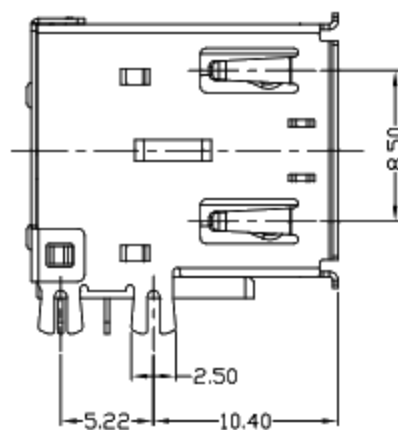
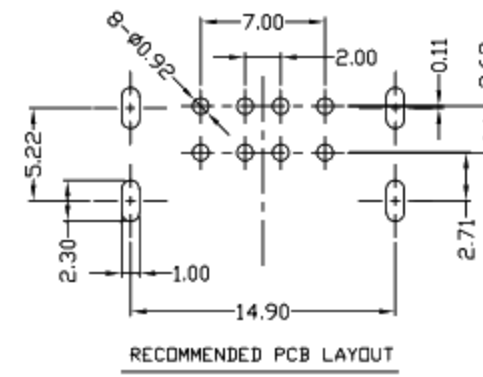
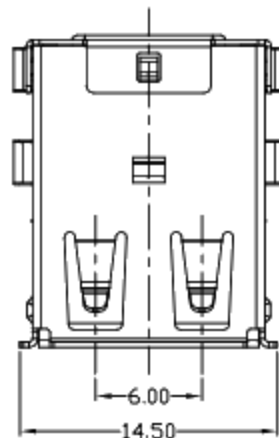

NOTES:

- ELECTRICAL:
  - VOLTAGE CURRENT RATING: 2AMP,30V AC;
  - INSULATION RESISTANCE: 1000MΩ MIN;
  - CONTACT RESISTANCE: 30mΩ MAX;
  - WITHSTANDING VOLTAGE: 500V AC;
  - OPERATING TEMPERATURE:-55°C TO +85°C.
- Mechanical:
  - Mating Force: 35N MAX
  - Unmating Force: 10N MIN.
- DIMENSIONS MARKED "▼" TO BE CHECKED BY Q.C & IPQC.

4.PART NO.

1:1Au 1U\*  
6:1Au 30U\*

W:WHITE  
B:BLACK

1:PBT  
2:PA6T  
3:PA9T  
4:LCP

Bill of materials:

NO	PARTS	MATERIAL	QTY	FINISHING	UNITS	mm
5	CLIP	STAINLESS STEEL	1	PLATED NICKEL	X. ±0.35	X.* ±2*
4	BACK COVER	SPCC	1	PLATED NICKEL	.X ±0.3	.X* ±1*
3	HOUSING	LCP+30%GF	1	UL94V-0	.XX ±0.25	.XX*
2	SHELL	COPPER ALLOY	1	PLATED NICKEL	.XXX ±0.15	.XXX*
1	TERMINAL	COPPER ALLOY	8	PLATED GOLD/TIN	THESE DRAWINGS AND SPECIFICATIONS ARE THE PROPERTY OF ACCURATE INNOTECH INC AND SHALL NOT BE REPRODUCED, COPIED OR USED IN ANY MANNER WITHOUT THE PRIOR WRITTEN CONSENT OF ACCURATE INNOTECH INC.	
					Q'TY	

**廣東科斯達電子科技有限公司**

TITLE: USB AF 双层半包 长胶半弹鱼叉脚	PART NO.:			
DR: gan 2017/7/25	DWG NO.:			
CHKD: gan 2017/7/25	SCALE	SHEET	REV.	CUSTOMER DRAWING
APPD:	1:1	1/1	B	