

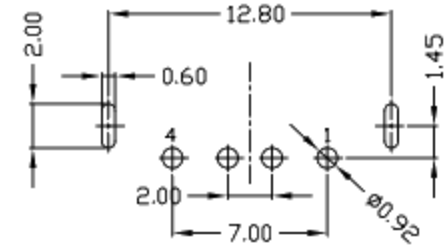

RoHS
Compliant
2002/95/EC

| REV. | ECN. | NO. | APPD. |
|------|------|-----|-------|
| | | | |
| | | | |
| | | | |

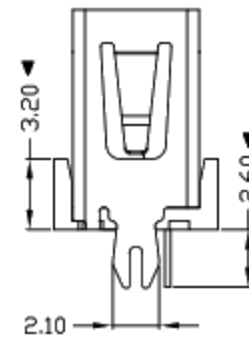
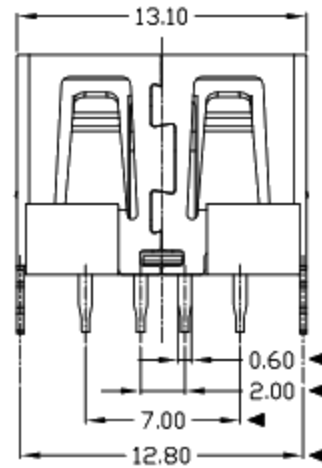
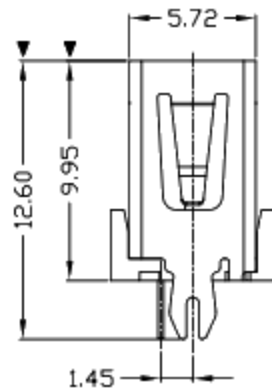
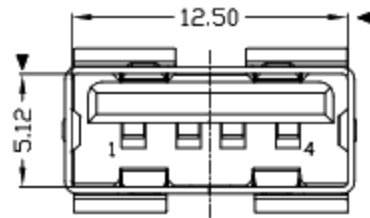

RECOMMENDED PCB LAYOUT

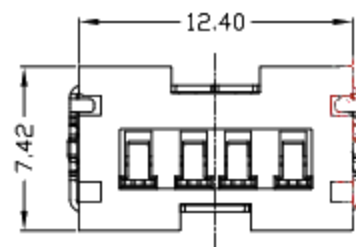

NOTES:

- ELECTRICAL:
 - VOLTAGE CURRENT RATING: 2AMP, 30V AC;
 - INSULATION RESISTANCE: 1000M Ω MIN;
 - CONTACT RESISTANCE: 30m Ω MAX;
 - WITHSTANDING VOLTAGE: 500V AC;
 - OPERATING TEMPERATURE: -55°C TO +85°C.
- Mechanical:
 - Mating Force: 35N MAX
 - Unmating Force: 10N MIN.
- DIMENSIONS MARKED "▼" TO BE CHECKED BY Q.C & IPQC.

4. PART NO.

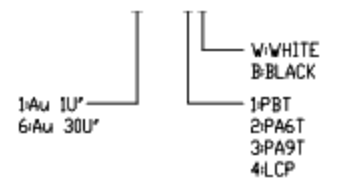

Bill of materials:

| NO | PARTS | MATERIAL | QTY | FINISHING |
|----|----------|---------------|-----|-----------------|
| 3 | HOUSING | PBT/LCP+30%GF | 1 | UL94V-0 |
| 2 | SHELL | COPPER ALLOY | 1 | PLATED NICKEL |
| 1 | TERMINAL | COPPER ALLOY | 4 | PLATED GOLD/TIN |

| X. | X.* | UNITS |
|-------|-----|----------|
| ±0.35 | ±2* | mm |
| ±0.3 | ±1* | MAT'L |
| ±0.25 | * | SEE NOTE |
| ±0.15 | * | FINISH |
| | | SEE NOTE |
| | | Q'TY |

廣東科斯達電子科技有限公司

| | | | |
|--|--|-----------|------------------|
| TITLE: USB 5P DIP 180° (10.0)无卷边 的叉脚 | | PART NO.: | |
| DR: gan 2014/12/10 | | DWG NO.: | |
| CHKD: gan 2014/12/10 | | SCALE | SHEET |
| APPD: | | 1:1 | 1/1 |
| | | REV. | CUSTOMER DRAWING |
| | | B | |

THESE DRAWINGS AND SPECIFICATIONS ARE THE PROPERTY OF ACCURATE INNOTECH INC AND SHALL NOT BE REPRODUCED, COPIED OR USED IN ANY MANNER WITHOUT THE PRIOR WRITTEN CONSENT OF ACCURATE INNOTECH INC.

