

ZONE		SYMBOL	REVISION	APPROVAL	DATE
			INITIAL	Lucky	06/20/20'

- NOTES:
SPECIFICATION:
- CURRENT RATING: 3.0A MAX
 - DIELECTRIC WITHSTAND VOLTAGE: 100VAC
 - TEMPERATURE RANGE: -30 °C ~ 85 °C
 - CONTACT RESISTANCE: 40 MILLIONHM MAX
 - INSULATION RESISTANCE: 100 MEGOHMS MIN.
 - INSERTION FORCE : 5N~20N
 - UNMATING FORCE: 8N~20N
 - DURABILITY:10,000 CYCLES

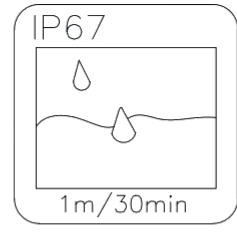

A1	GND	B12	GND
A4	VBUS	B9	VBUS
A5	CC1	B8	SBU2
A6	DP1	B7	DN2
A7	DN1	B6	DP2
A8	SBU1	B5	CC2
A9	VBUS	B4	VBUS
A12	GND	B1	GND
PIN	SIGNAL NAME	PIN	SIGNAL NAME

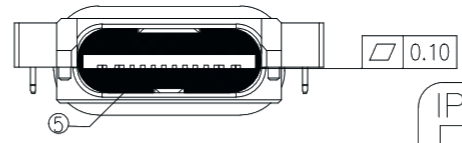
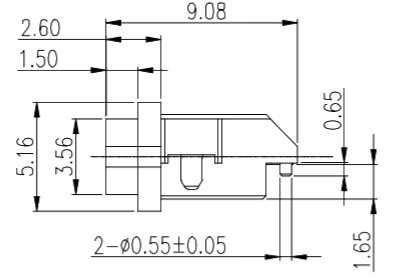
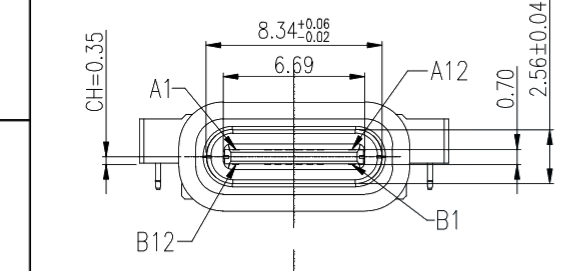
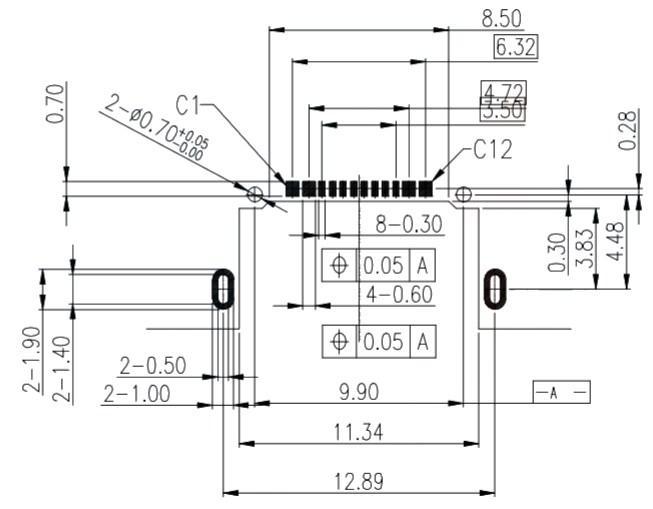
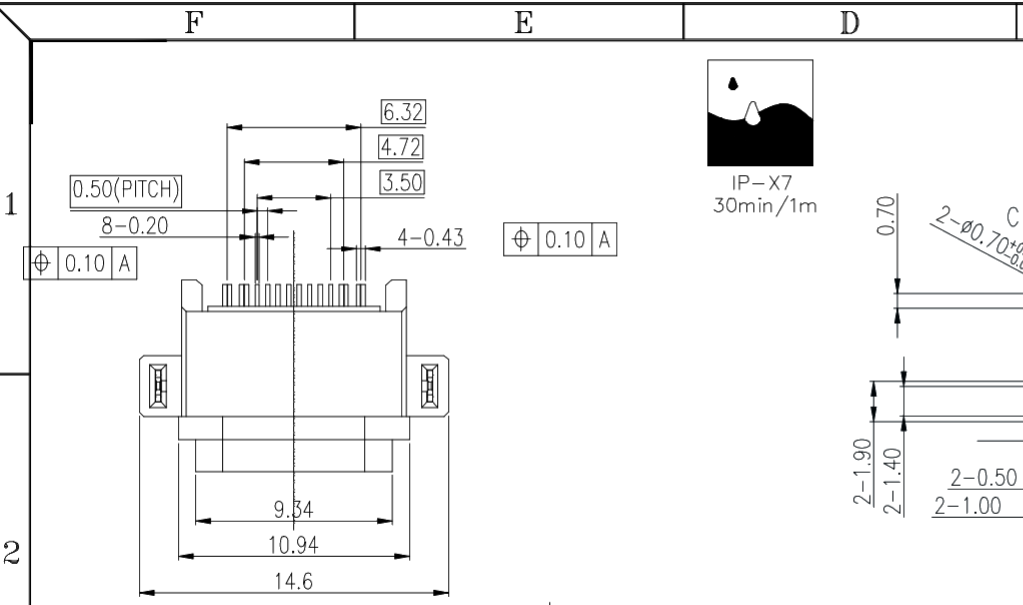
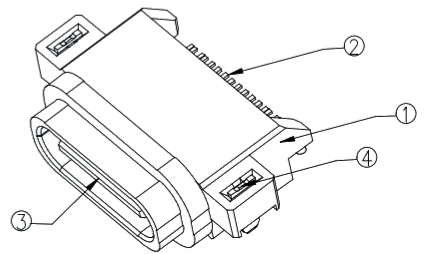
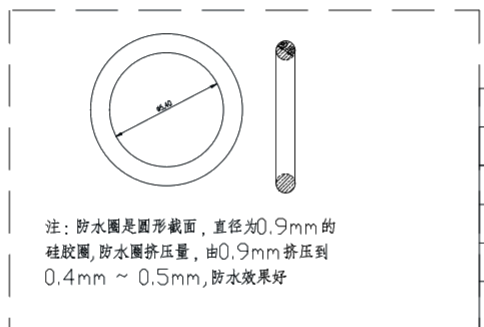
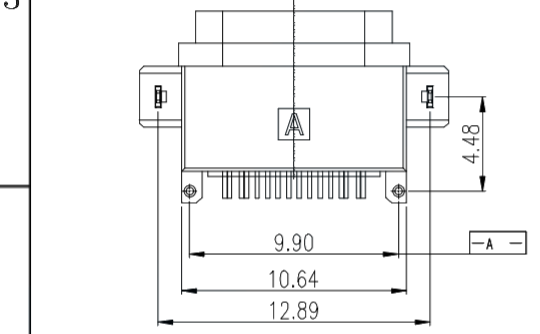

5	Epoxy			BLACK
4	Contact 3	2	SUS304 1/2H	Ni Plating T=0.25mm
3	Housing 2	1	PA10T (G.F30%)	BLACK
2	Contact 1&2	16	Phosphor bronze C5191R-EH	Au3u"Plating T=0.15mm
1	Housing 1	1	PA10T (G.F30%)	BLACK
ITEM	PART NAME	Q'TY	FINISH	NOTE

广东科斯达电子科技有限公司
KSDKG Guang dong Keside Electronic Technology Co., Ltd.

PART NAME	TYPE C 16PIN 沉板式	TOLERANCE UNLESS	0.0±0.2	UNIT: mm
PART NO.		OTHERWISE SPECIFIED:	0.00±0.1 0.000±0.05	

DESIGN	Lucky	DATE	2021.10.8	SCALE	5:1
DRAWING	liao Y K	DATE	2021.10.8	MATERIAL	*
CHECK	Abel	DATE	2021.10.8	DWG. no.	
APPROVAL		DATE	2021.10.8	SHEET	