

RG	Red	红色
	Green	翠绿色
G	Green	绿色
W	White	白色
U	Blue	蓝色
Y	Yellow	黄色
O	Orange	橙色
R	Red	红色
灯发光颜色 X		
Emitted color X		

CIRCUIT

Type	Switch Action		Circuit
Lock	Normal ON	Push to lock ON	
Connected Terminals	1 - 2	2 - 3	
	4 - 5	5 - 6	
No Lock	Normal ON	Push to lock ON	
Connected Terminals	1 - 2	2 - 3	
	4 - 5	5 - 6	
LED Circuit			

P.C.B. LAYOUT

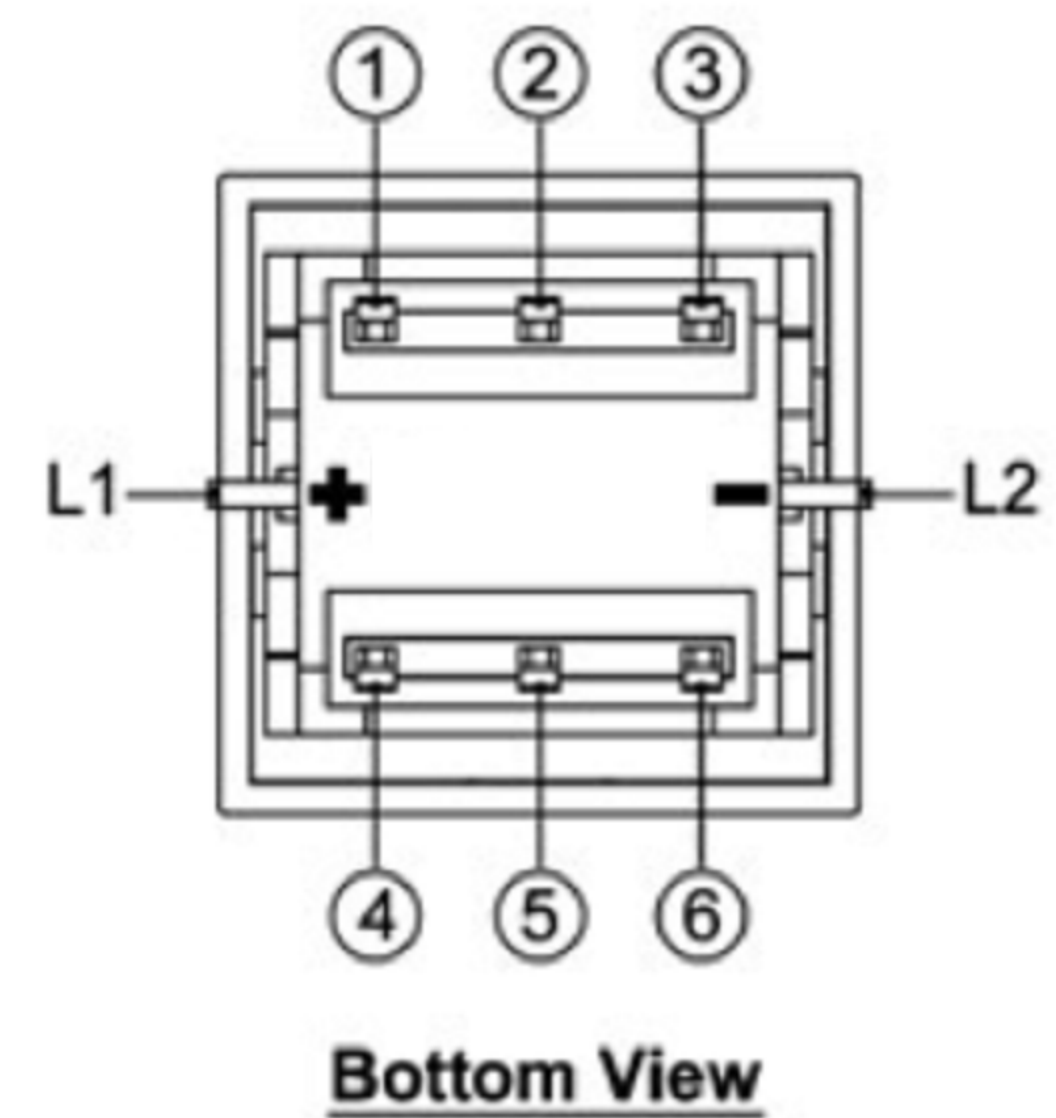
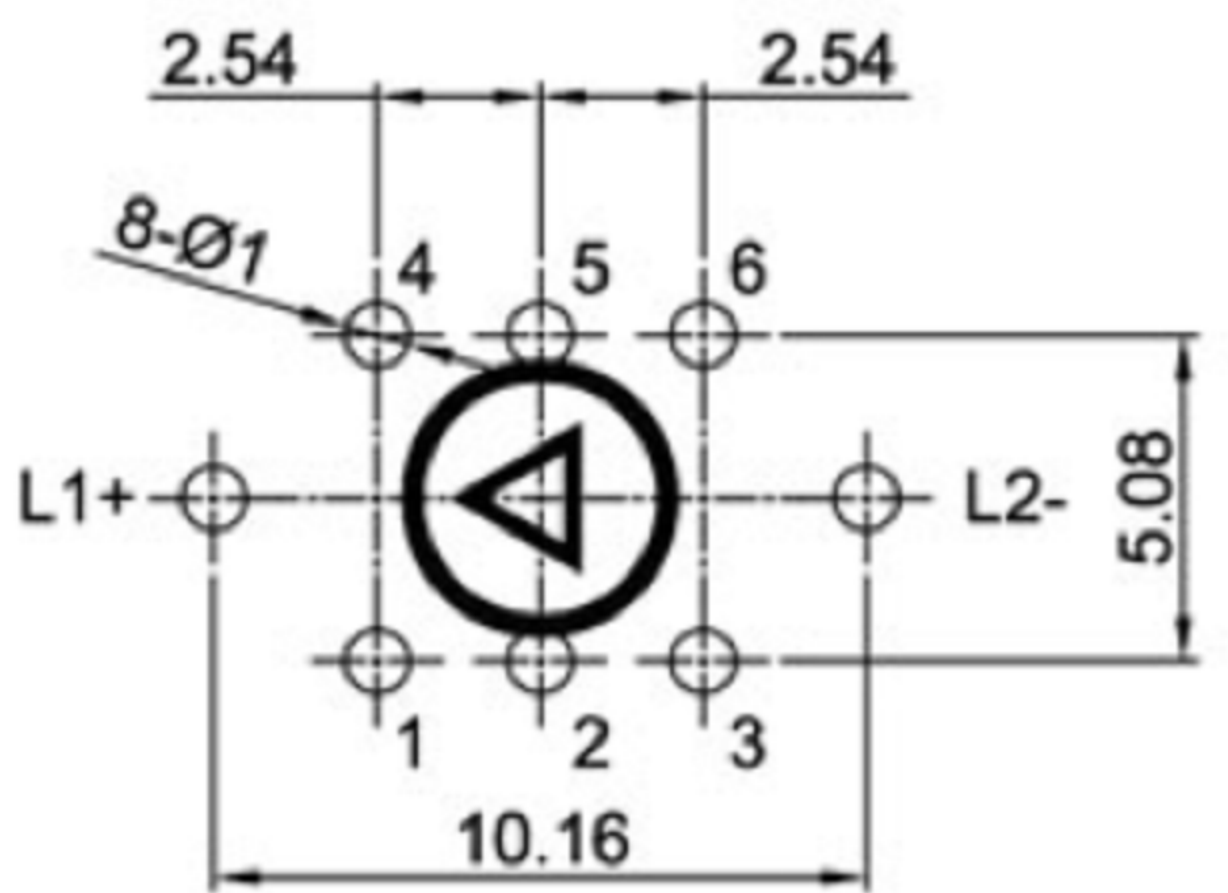

NO.	DESCRIPTION	QTY	MATERIAL	PLATING
7	CAP	1	ABS / PC	Black
6	LED	1		
5	FIXITY	1	PA66	Black
4	CONTACT	1	PHOSPHOR BRONZE	Ag plated
3	TERMINAL	2	BRASS	Ag plated
2	CASE	1	PA66	Black
1	KNOB	1	PA66	Black/White

广东科斯达电子科技有限公司
GUANG DONG KE SI DA ELECTRONIC TECHNOLOGY CO., LTD.

TOLERANCE UNLESS OTHERWISE STATED:
 Up to 5 ±0.2
 Above 5 ~ 15 ±0.3
 Above 15 ~ 30 ±0.4
 Above 30 ~ 50 ±0.5
 Angle ±0.3

3RD. ANGEL'S

UNITS MM

DRAWN BY:	DATE	MAT'L	TITLE	SWITCH
Jack Lu	12/27/22		MODLE	TACT SWITCH WITH LED
CHECKED BY:	DATE	FINISH	DWG NO.	SIZE
Jacky Chen	12/27/22			A4
APPROVED BY:	DATE	SCALE	PART NO.	VER
Tony Kao	12/27/22	1:1		R
		SHEET NO.		
		1 of 1		

ITEM NO.	DESCRIPTION	DRAWN	DATE