

ZONE	SYMBOL	REVISION	APPROVAL	DATE
A		INITIAL	Lucky	06/20/20'

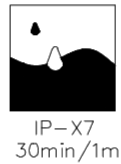

- SPECIFICATIONS:
- 1.RATED VOLTAGE:DC 12V
RATED CURRENT: 1A
 - 2.INSULATION RESISTANCE:A VOLTAGE OF 500V D.C. SHALL BE APPLIED TO THE TERMINALS, AFTER WHICH MEASUREMENT SHALL BE MADE. A GAUGE FOR THE MEASUREMENT SHALL BE USED THE INSULATEDGAUGE.
 - 3.CONTACT RESISTANCE:30mΩ OR LESS
 - 4.VOLTAGE PROOF:500V AC FOR ONE MINUTE
 - 5.DURABILITY:5,000 INSERTION/REMOVAL CYCLES(MINIMUM)
 - 6.INSERTION FORCE:0.6KGF~2.0KGF
 - 7.WITHDRAWAL FORCE:0.6KGF~2.0KGF
 - 8.WATER PROOFNESS:This product is based on IPX5/7 of the JIS Standard.
 - 9.USING PLUG:φ 3.5MM. 4-POLE STEREO EARPHONE(LCH/RCH/GND/MIC) PROVIDED THAT THEY CONFORM TO JIS C6560
 - 10.HOUSING STERNGTH IS 50N MAX

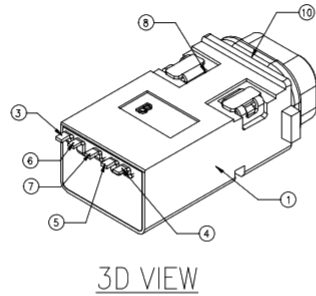
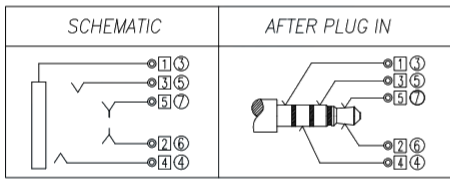
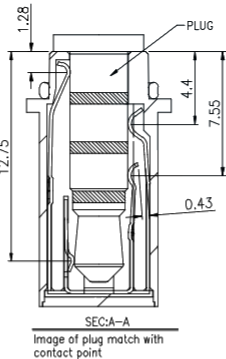
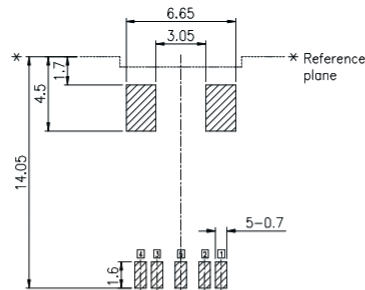
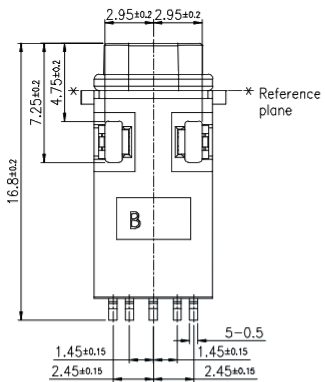
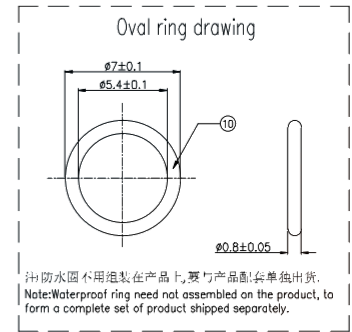
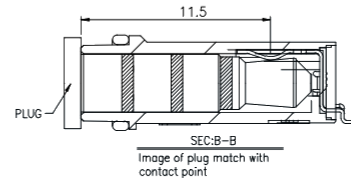
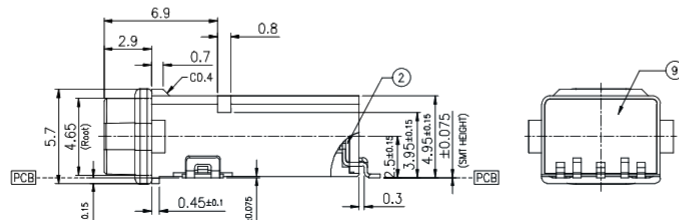
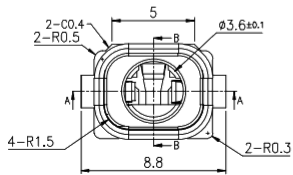
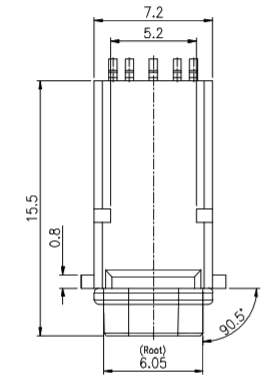

□ : TERMINAL NO. ○ : ITEM NO.

10	Oval ring	----	1	SILICONE	----
9	BOND	----	1	EPOXY	----
8	TERMINAL	----	2	C2680 t=0.2	Gold flash plating Nickel 40u"min underplate
7	TIP SPRING-2	5	1	Ti-Cu t=0.2	
6	TIP SPRING-1	2	1	Ti-Cu t=0.2	
5	RING SPRING-2	3	1	Ti-Cu t=0.2	
4	RING SPRING-1	4	1	Ti-Cu t=0.2	
3	EARTH SPRING	1	1	Ti-Cu t=0.2	
2	COVER	----	1	PA9T+33%GF(GN2330)	UL-94V-0
1	HOUSING	----	1	PA9T+33%GF(GN2330)	UL-94V-0
ITEM	PART NAME	TERMINAL	QTY	MATERIAL	REMARK

广东科斯达电子科技有限公司
KSDKG Guang dong Keside Electronic Technology Co., Ltd.

DRAWING:	Lucky	DATE:	2020.20.06	SCALE	5: 1
CHECK:	liao Y K	DATE:	2020.20.06	MATERIAL	*
APPROVAL:	Abel	DATE:	2020.20.06	DWG. no.	A
DRAWING NO.				SHEET	1/1

PART NAME:	3.5mm STEREO JACK	TOLERANCE UNLESS	0.0±0.2	UNIT:	mm
PART NO.		OTHERWISE SPECIFIED:	0.00±0.1 0.000±0.05		