

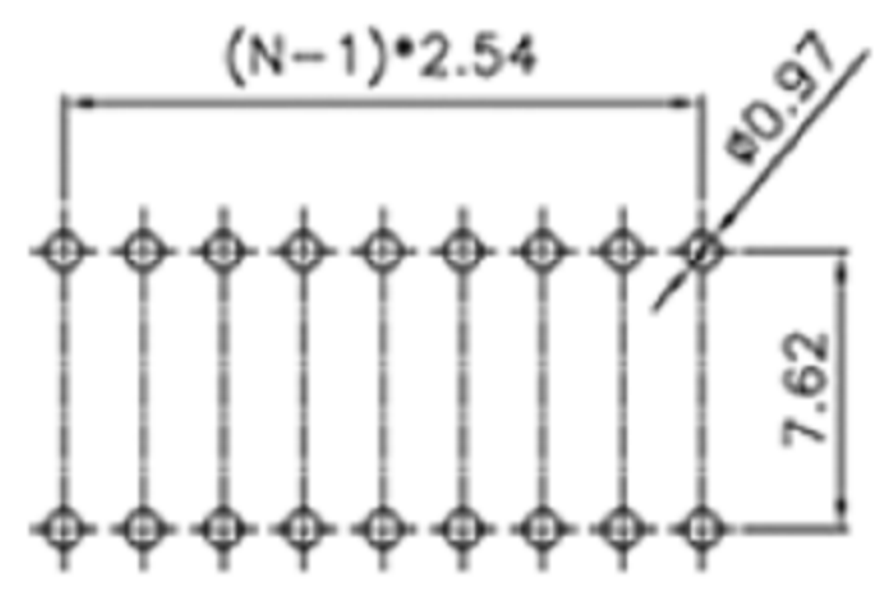

DS Type

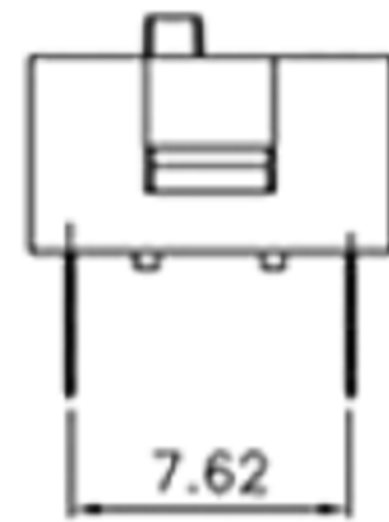
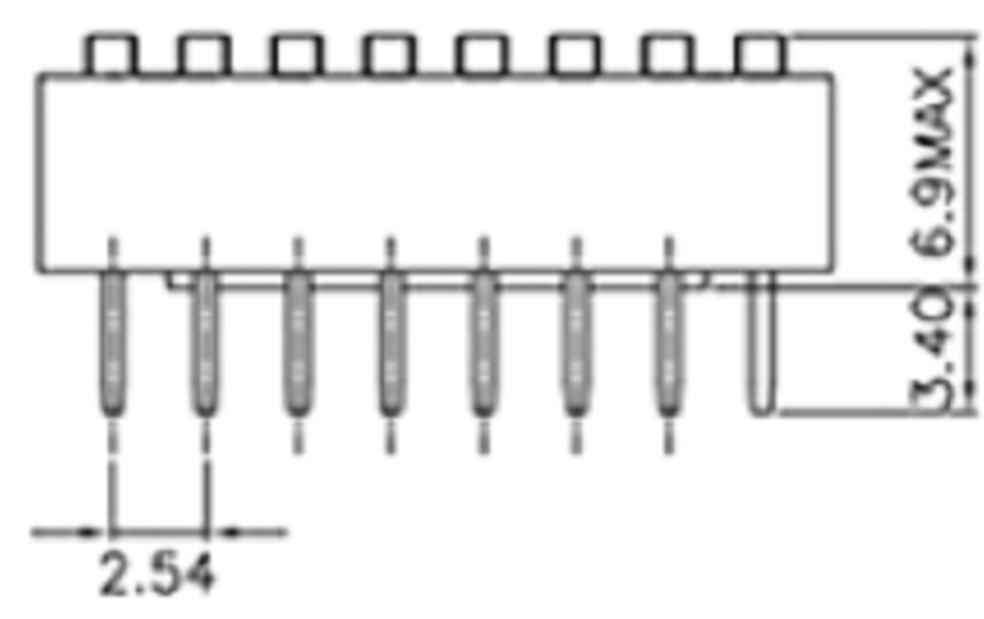
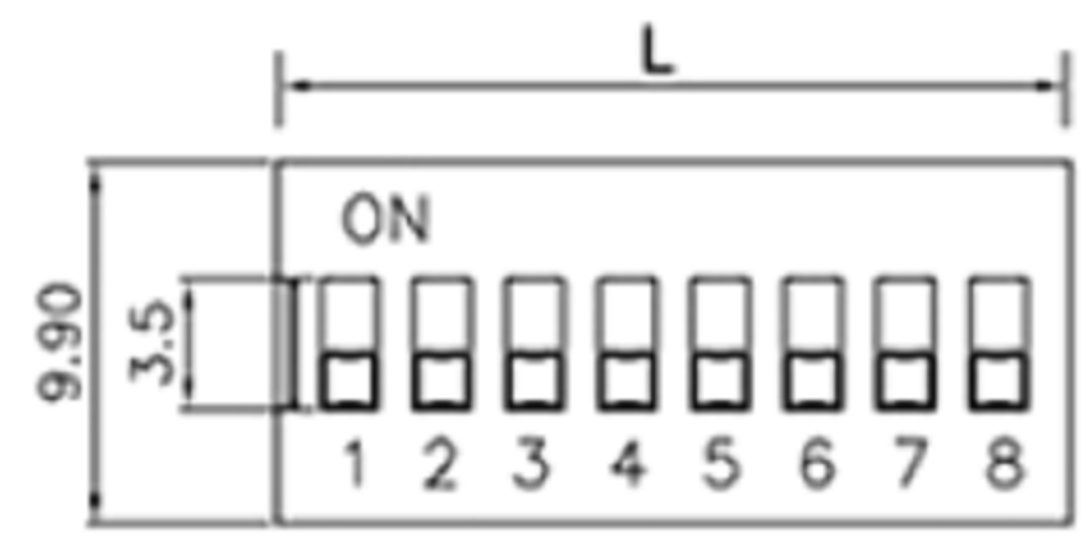

PCB LAYOUT

DA Type

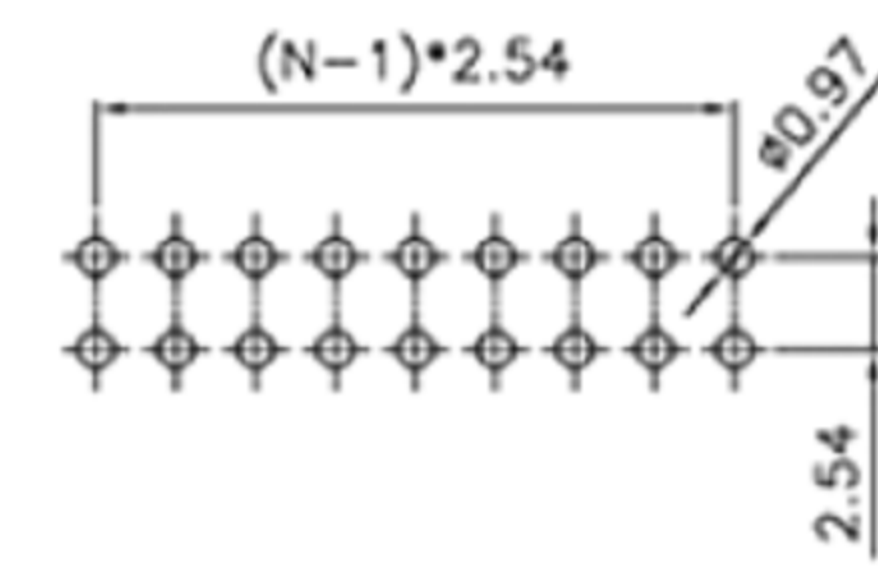
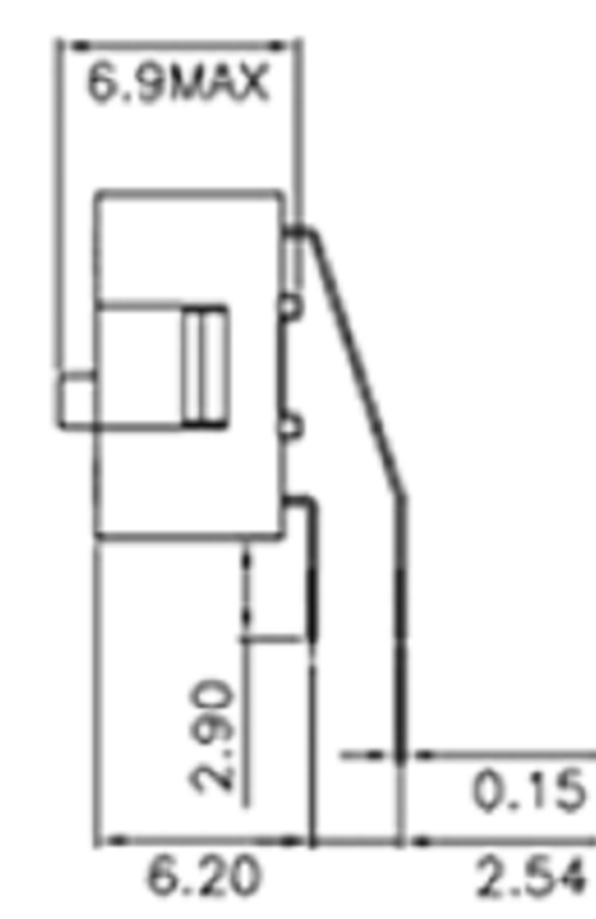
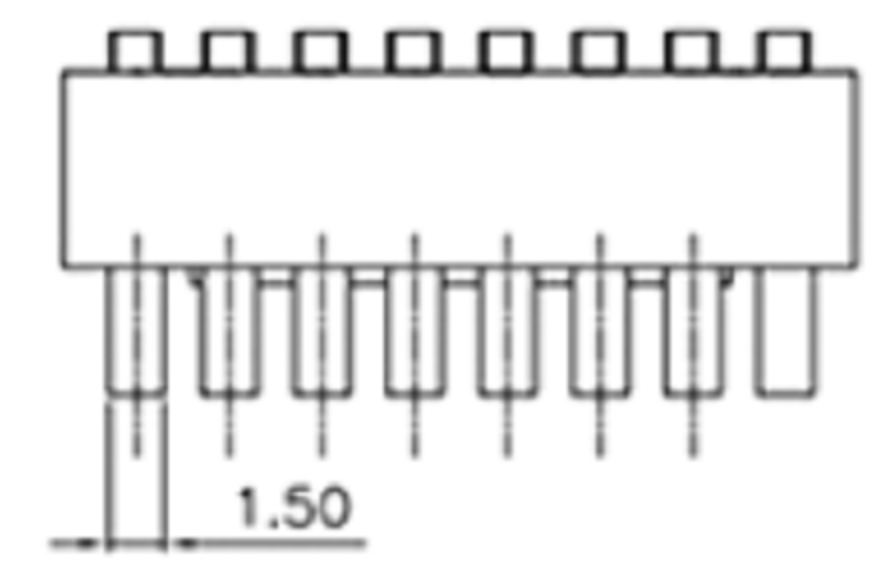
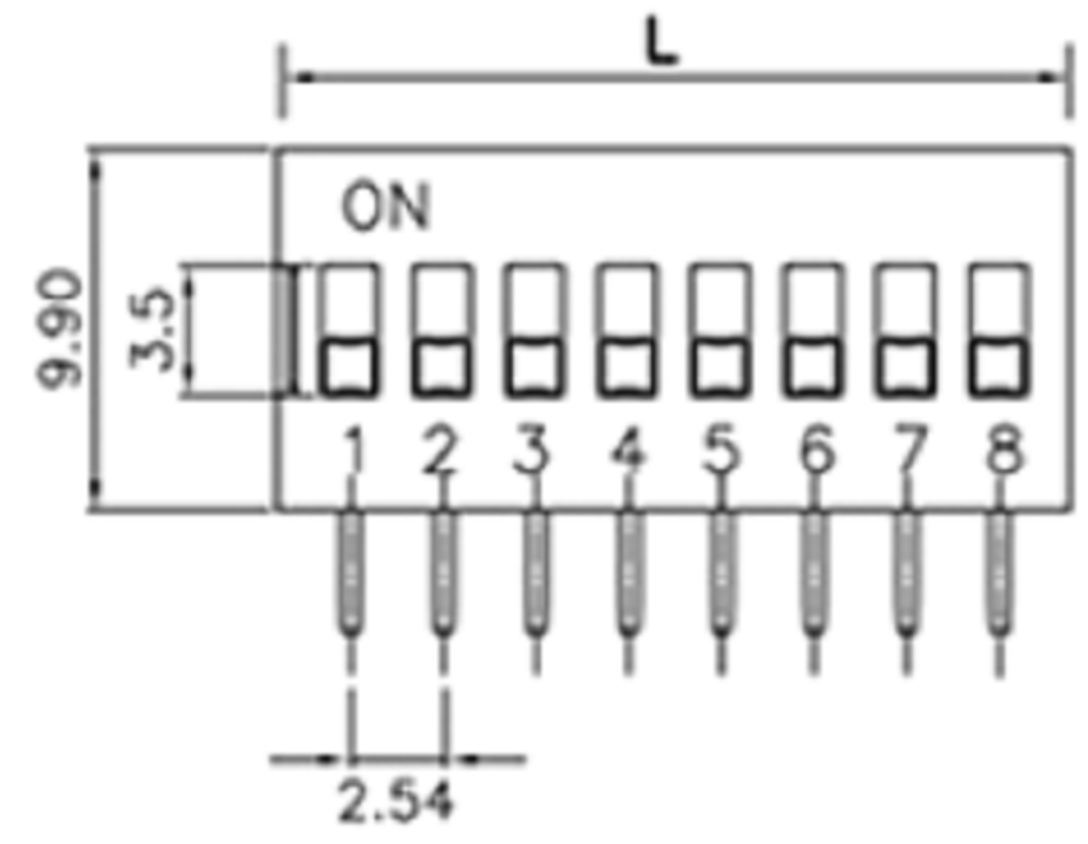

PCB LAYOUT

DP Type

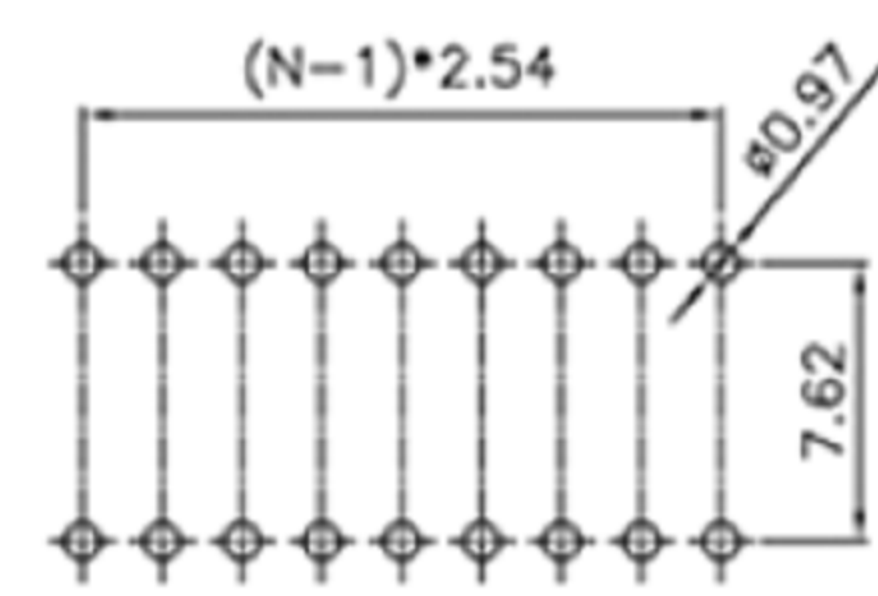
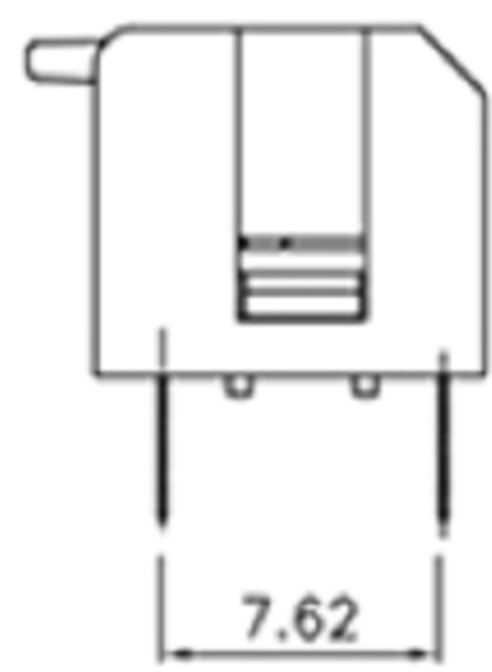
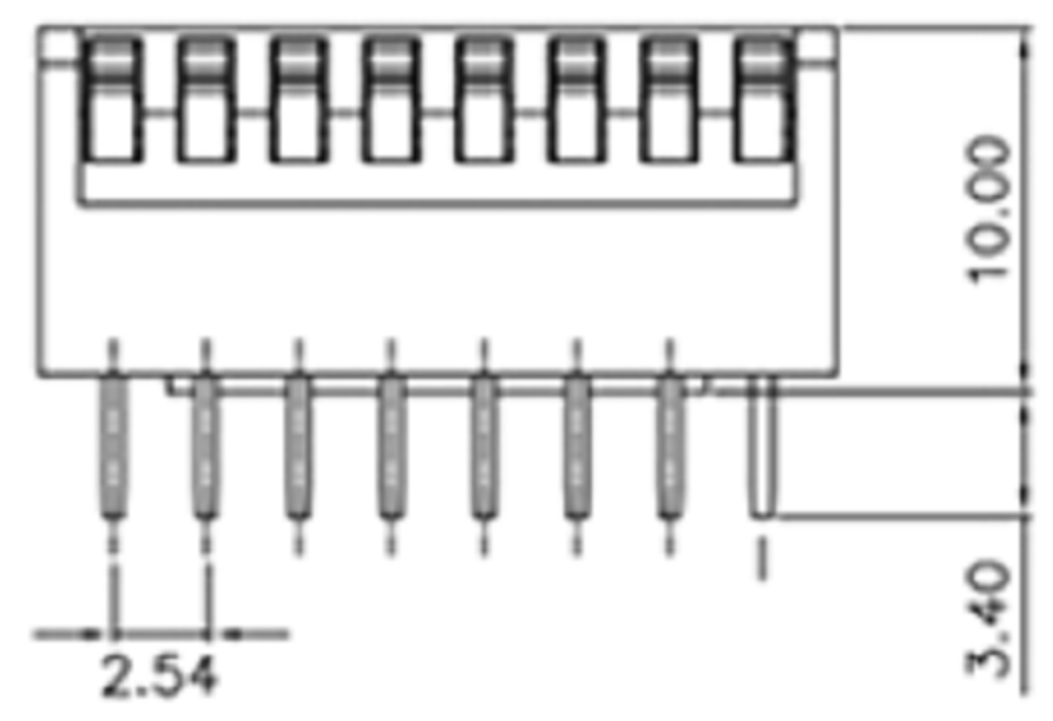
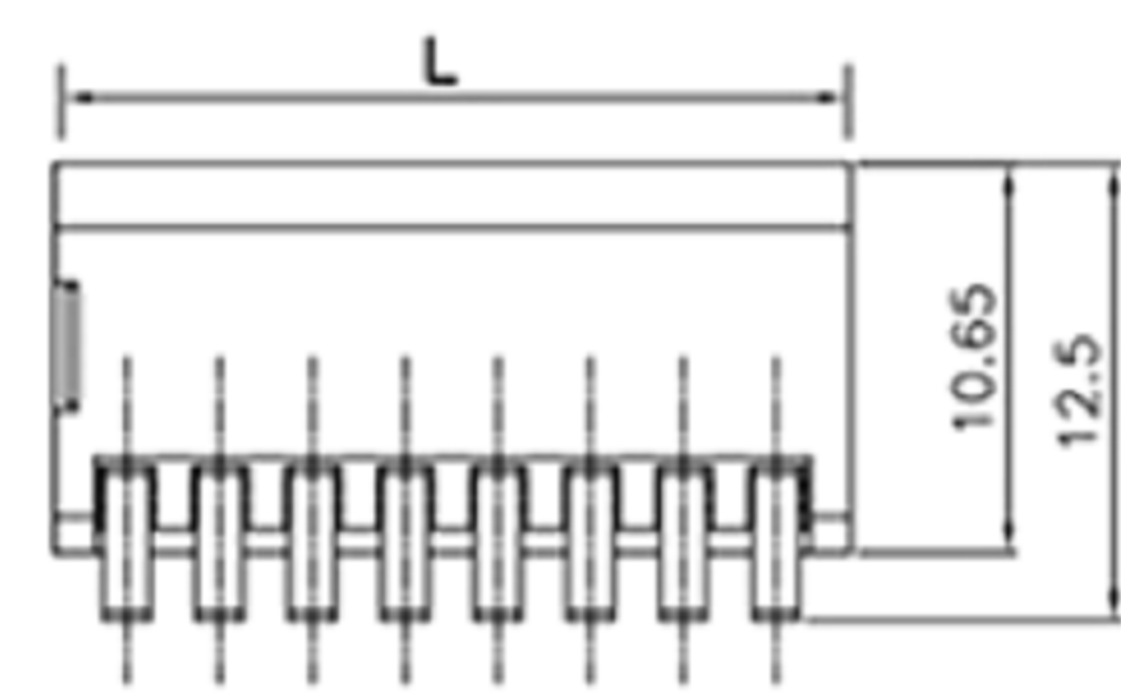

PCB LAYOUT

广东科斯达电子科技有限公司
GUANG DONG KE SI DA ELECTRONIC TECHNOLOGY CO., LTD.

TOLERANCE UNLESS OTHERWISE STATED :
 Up to 5 ±0.2
 Above 5 ~ 15 ±0.3
 Above 15 ~ 30 ±0.4
 Above 30 ~ 50 ±0.5
 Angle ±0.3

3RD. ANGEL'S

UNITS MM

DRAWN BY:	DATE	MAT'L	TITLE	SWITCH
Jack Lu	12/27/22			
CHECKED BY:	DATE	FINISH	MODLE	TACT SWITCH WITH LED
Jacky Chen	12/27/22			
APPROVED BY:	DATE	SCALE	DWG NO.	
Tony Kao	12/27/22	1 : 1		
		SHEET NO.	PART NO.	
		1 of 1		

ITEM NO.	DESCRIPTION	DRAWN	DATE