

REV	ECN No.	DESCRIPTION	DESIGN	DATE
A0		NEW RELEASE	蒋建银	2018.01.23

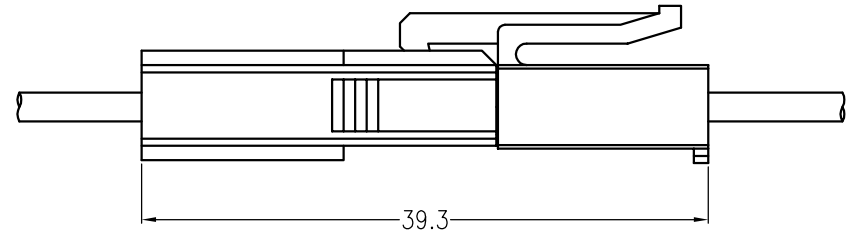
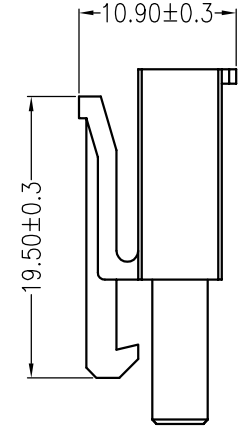
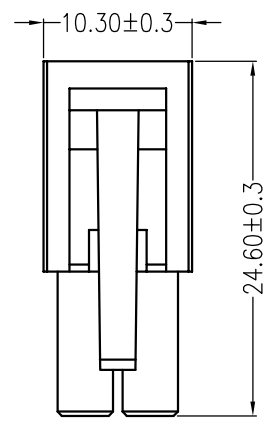

**主要技术参数 Main Specifications**

线数 (Poles): 02 to 08  
 额定电阻 (Contact resistance):  $\leq 20m\Omega$   
 绝缘电阻 (Insulation resistance):  $\geq 1000M\Omega$   
 额定电压 (Rated voltage): 300 V AC DC  
 额定电流 (Rated current): 10A AC DC  
 耐电压 (Withstand Voltage): 1500V AC/minute  
 温度范围 (Temperature Range):  $-25^{\circ}C \sim +85^{\circ}C$

**ORDER INFORMATION:**

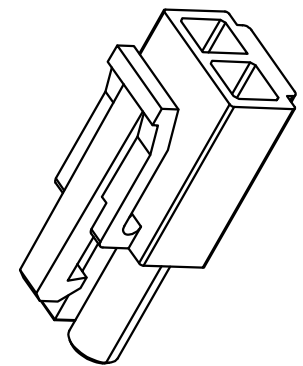
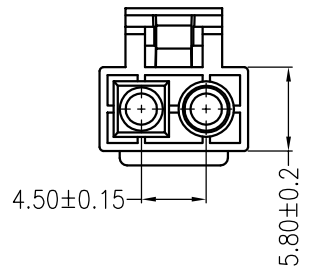
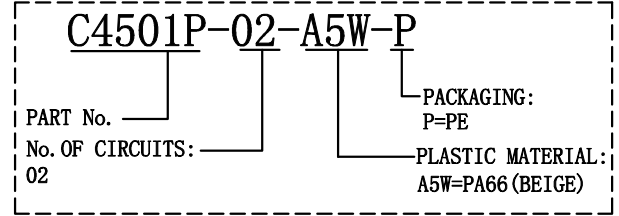

ITEM	COMPONENT	Q'TY	MATERIAL	FINISH
C				
B				
A	HOUSING	1 PCS	PA66	COLOR:(BEIGE) UL94-V2

<b>广东科斯达电子科技有限公司</b> GUANG DONG KE SI DA ELECTRONIC TECHNOLOGY CO., LTD.			<b>TITLE:</b> C4501P 4.0mm PITCH HOUSING	
X.±0.5	X.±5'	<b>USE:</b> CUSTOMER	<b>PART NO.:</b> C4501P-02-A5W-P	
.X±0.3	.X±2'			
.XX±0.25	.XX±1'	<b>CHKD:</b> 田峰	<b>DWG NO.:</b> GCCP-0614	
---	---	<b>DR:</b> 蒋建银	<b>SCALE</b> 1 : 1	<b>SHEET</b> 1 / 1
<b>UNITS:</b> mm				

REV	ECN No.	DESCRIPTION	DESIGN	DATE
A0		Release	蒋建银	2018.01.23

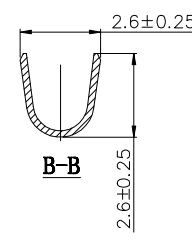
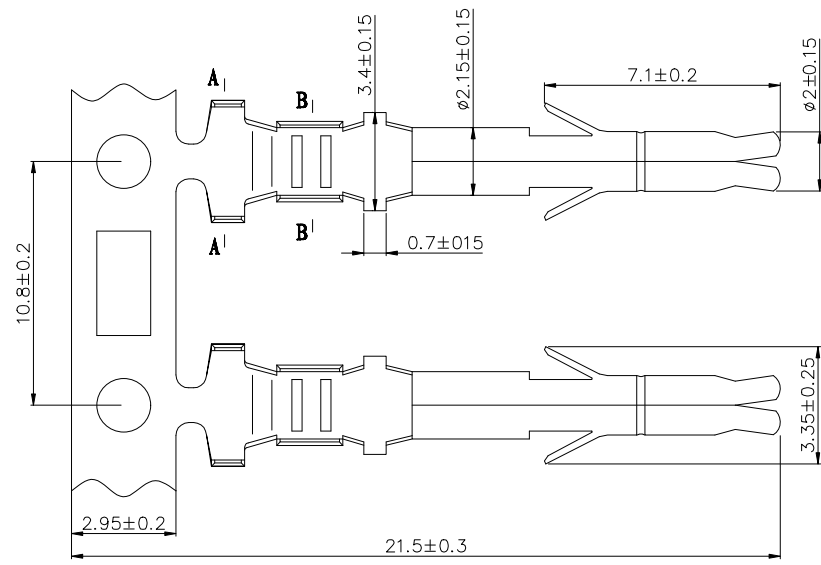
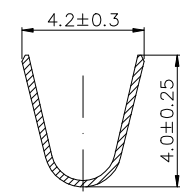
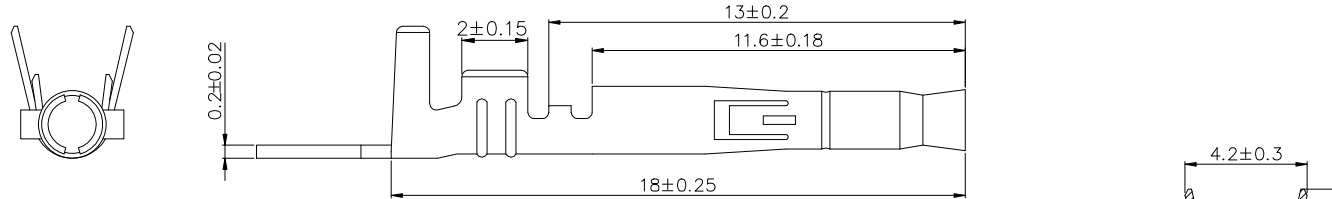

Ordering Information & Specification:

Part No	Wire Range	Insulation O.D.	Material	Finish	Qty/Reel
C4501PT-1	AWG #22~#18	1.6~2.80mm	Phosphor bronze	Sn-plated	

 广东科斯达电子科技有限公司  
GUANG DONG KE SI DA ELECTRONIC TECHNOLOGY CO., LTD.

TITLE: C4501PT

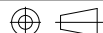
X. ±0.5	X. ±5°	USE:	CUSTOMER
.X ±0.3	.X ±2°	APPD:	邵敬和
.XX ±0.25	.XX ±1°	CHKD:	田峰
--	--	DR:	蒋建银
	UNITS: mm		

PART NO.:	C4501PT-1
DWG NO.:	GCDZ-0041
SCALE	1 : 1
SHEET	1 / 1

A

B

C

D

E

F

REV	ECN No.	DESCRIPTION	DESIGN	DATE
A0		NEW RELEASE	蒋建银	2018.01.23

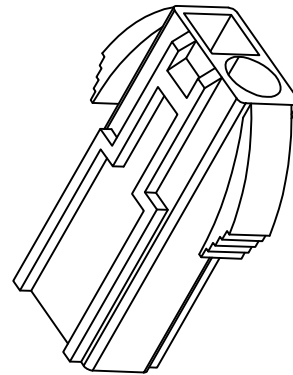
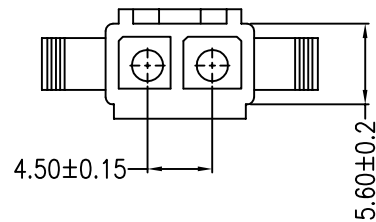
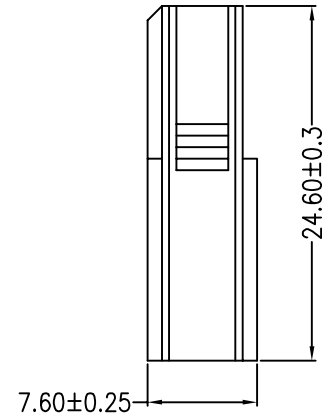
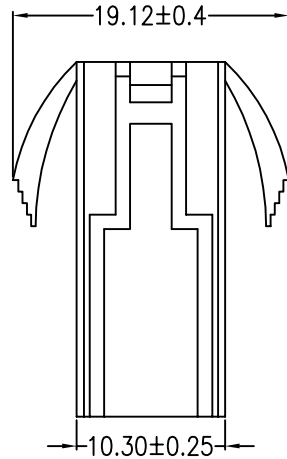

### 主要技术参数 Main Specifications

线数 (Poles): 02 to 08

额定电阻 (Contact resistance):  $\leq 20\text{m}\Omega$

绝缘电阻 (Insulation resistance):  $\geq 1000\text{M}\Omega$

额定电压 (Rated voltage): 300 V AC DC

额定电流 (Rated current): 10A AC DC

耐电压 (Withstand Voltage): 1500V AC/minute

温度范围 (Temperature Range):  $-25^{\circ}\text{C} \sim +85^{\circ}\text{C}$

### ORDER INFORMATION:

<b>C4501R-02-A5W-P</b>	
PART No. _____	PACKAGING: P=PE
No. OF CIRCUITS: _____	PLASTIC MATERIAL: A5W=PA66 (BEIGE)
02	

C				
B				
A	HOUSING	1 PCS	PA66	COLOR:(BEIGE) UL94-V2
ITEM	COMPONENT	Q'TY	MATERIAL	FINISH
 <b>广东科斯达电子科技有限公司</b> GUANG DONG KE SI DA ELECTRONIC TECHNOLOGY CO., LTD.		TITLE: C4501R		4.0mm PITCH HOUSING
X.±0.5	X.±5'	USE:	PART NO.:	
.X±0.3	.X±2'	APPD:	C4501R-02-A5W-P	
.XX±0.25	.XX±1'	CHKD:	DWG NO.:	
--	--	DR:	GCCP-0613	
	UNITS: mm	蒋建银	SCALE	SHEET
			1 : 1	1 / 1

A

B

C

D

E

F

REV	ECN No.	DESCRIPTION	DESIGN	DATE
A0		Release	蒋建银	2018.01.23

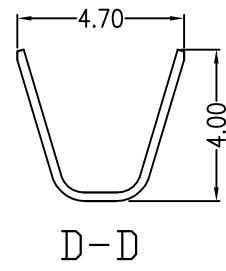
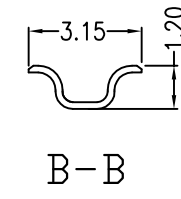
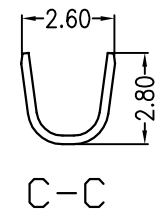
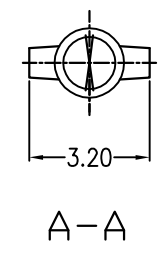
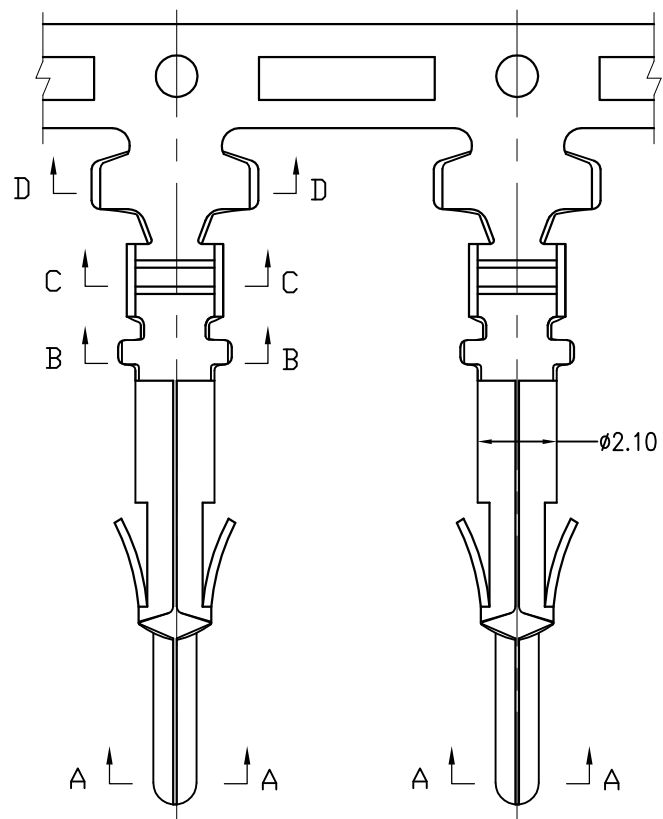
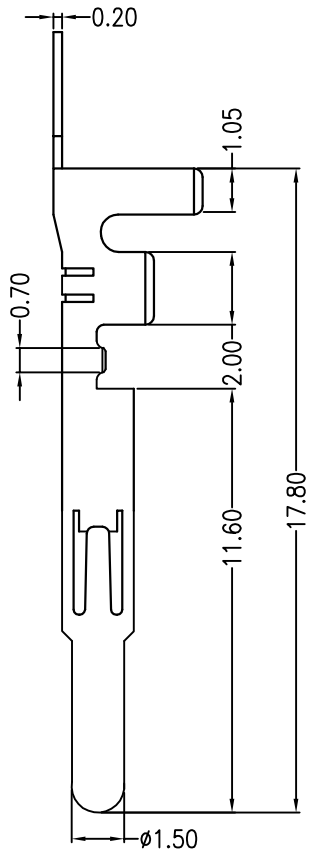

Ordering Information & Specification:

Part No	Wire Range	Insulation O.D.	Material	Finish	Qty/Reel
C4501RT-1	AWG #20~#24	1.5~2.50mm	Phosphor bronze	Sn-plated	

<b>广东科斯达电子科技有限公司</b> GUANG DONG KE SI DA ELECTRONIC TECHNOLOGY CO., LTD.		TITLE: C4501RT	
X.±0.5	X.±5'	USE: CUSTOMER	PART NO.: C4501RT-1
.X±0.3	.X±2'	APPD: 邵敬和	DWG NO.: GCDZ-0042
.XX±0.25	.XX±1'	CHKD: 田峰	SCALE: 1 : 1
--	--	DR: 蒋建银	SHEET: 1 / 1
UNITS: mm			