

CUSTOMER DRAWING

REV.	DESCRIPTION	APPVL. BY	DATE	ECN NO.
A	RELEASE	Ku Chou	25/04/19'	
B				
C				

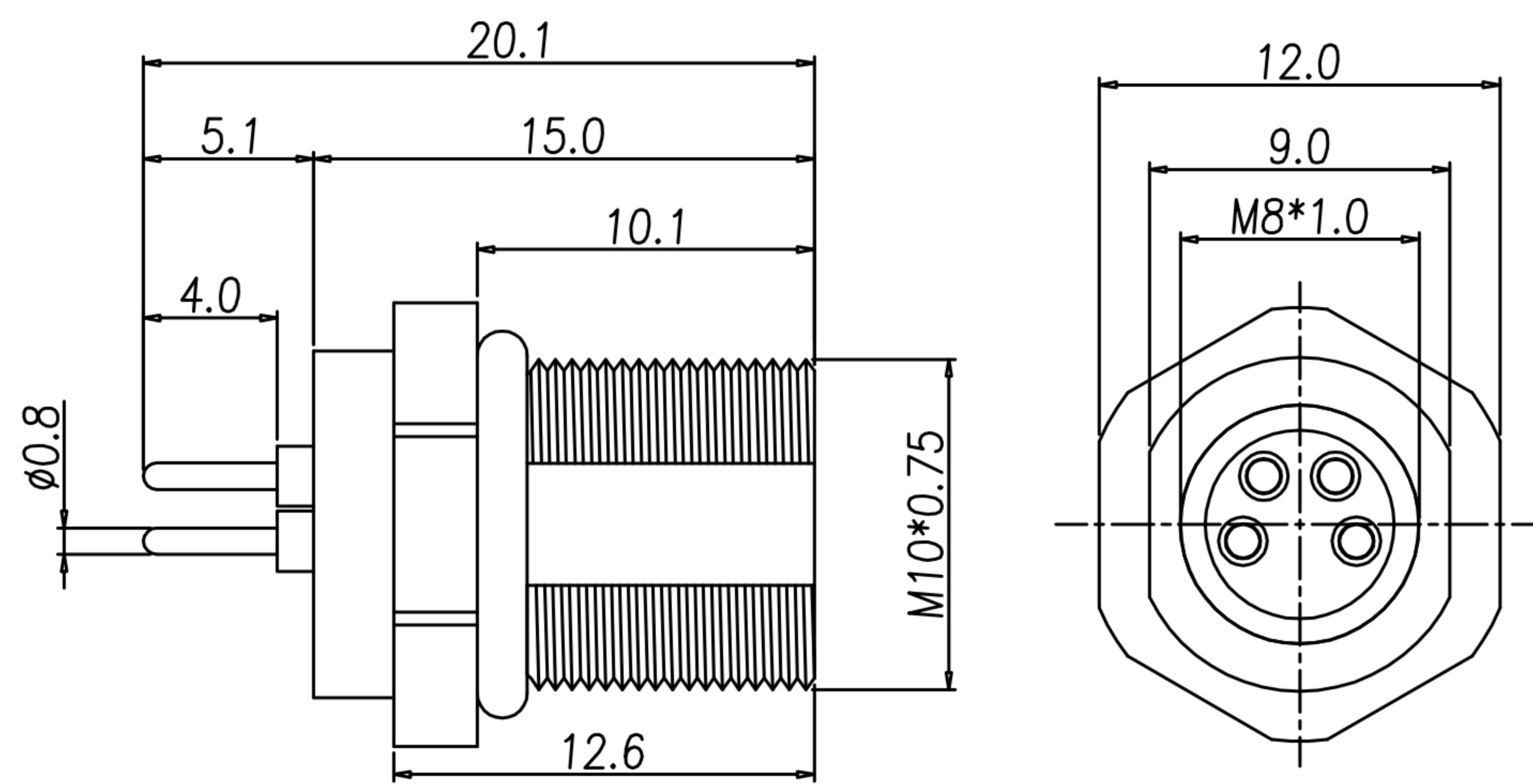
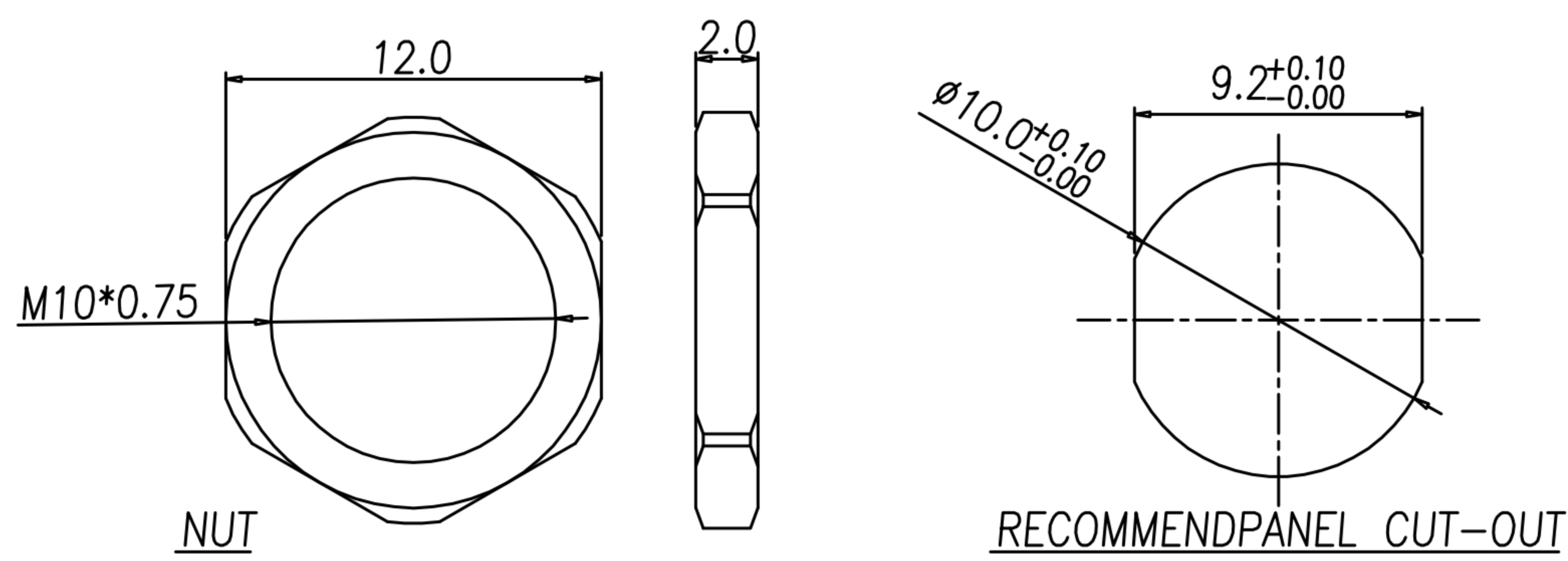
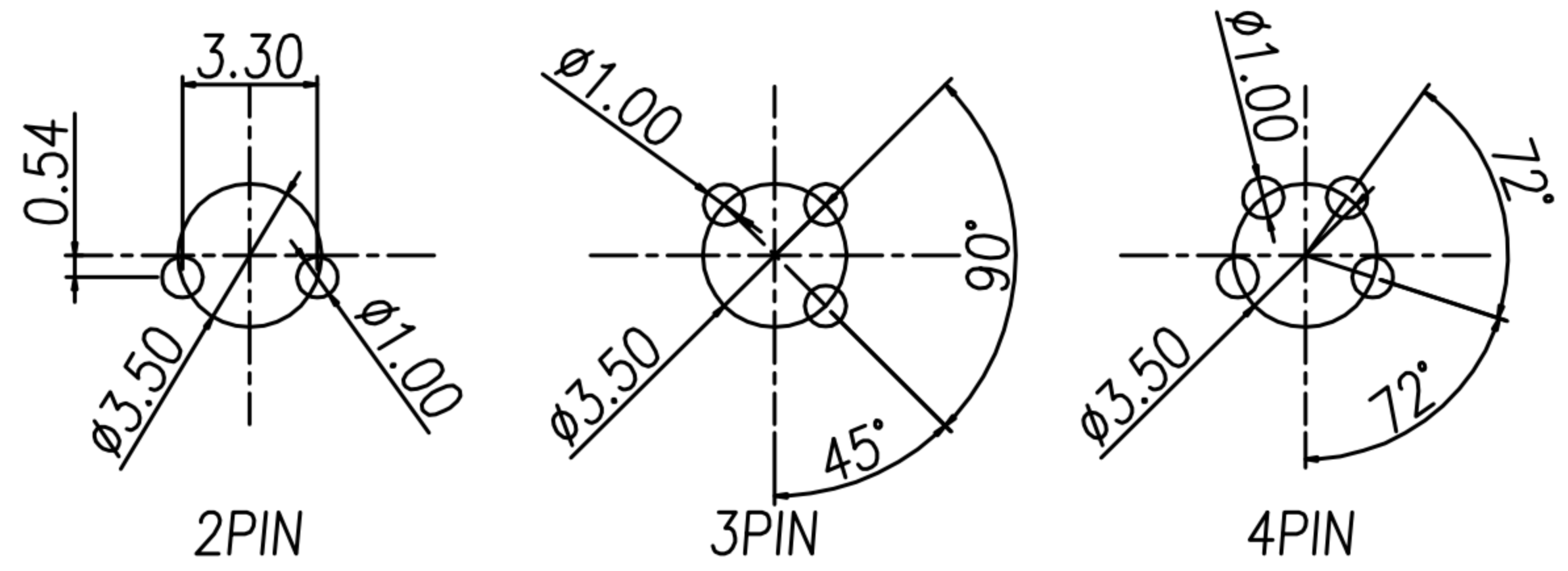

TABLE A

2PIN		3PIN		4PIN	
WP-02F3-02-11	WP-03F3-02-11	WP-04F3-07-11			
WP-02F3-03-11	WP-03F3-03-11	WP-04F3-08-11			
WP-04F3-07-11	GOLD FLASH	WP-04F3-08-11	GOLD 10u"		
WP-03F3-02-11	GOLD FLASH	WP-03F3-03-11	GOLD 10u"		
WP-02F3-02-11	GOLD FLASH	WP-02F3-03-11	GOLD 10u"		
PART No.	FINISH	PART No.	FINISH		



- NOTE:
- MATERIAL :
    - 1-1. HOUSING : PA66 ; COLOR : BLACK
    - 1-2. CONTACT : BRASS.
    - 1-3. SHELL : BRASS.
    - 1-4. NUT : BRASS.
    - 1-5. O-RING : EPDM ; COLOR : BLACK
  - FINISH :
    - 2-1. CONTACT : SEE TABLE A
    - 2-2. SHELL : NICKEL PLATED.
    - 2-3. NUT : NICKEL PLATED.
  - ELECTRICAL SPECIFICATION :
    - 3-1. Rated current : 4A
    - 3-2. Rated Voltage : 60V
    - 3-3. Water proof : IP67
  - Environmental :
    - 4-1. Operation Temperature : -40℃~105℃



RECOMMEND PCB LAYOUT

DRAWN	Emily Suen	APP'D	Ku Chou	UNIT	mm	TOLERANCE				TITLE	M8 (F) 前鎖M10*0.75插板式			SHEET	1
CHK'D	Ku Chou			SCALE	1:1					PART NO.	SEE TABLE A	DWG NO.	QC9308	VERSION	