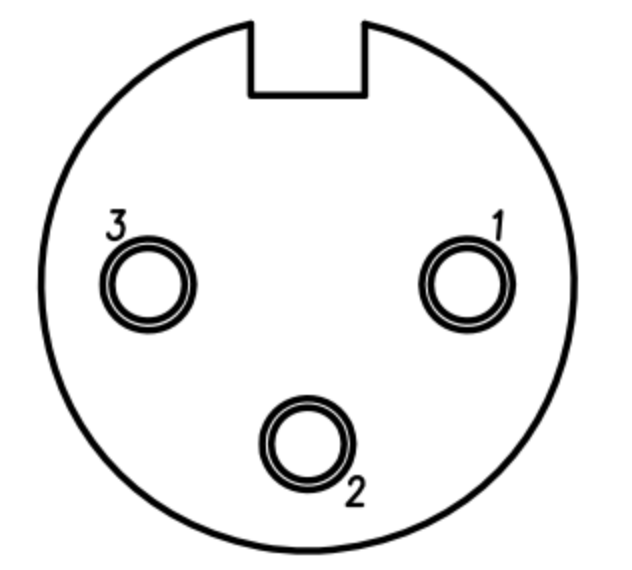
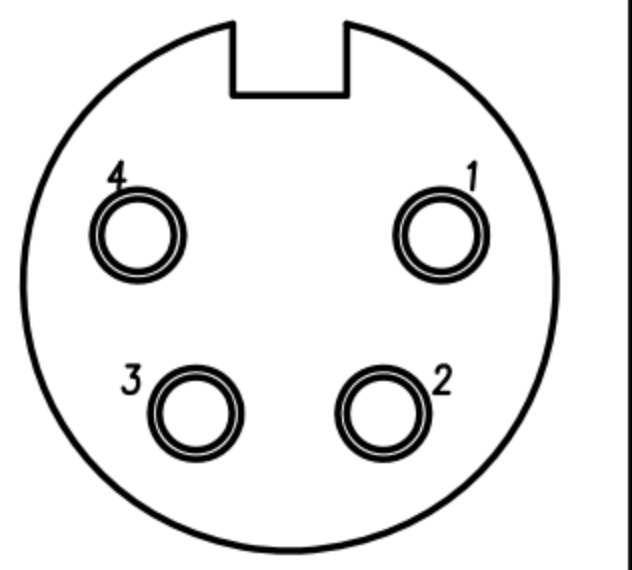
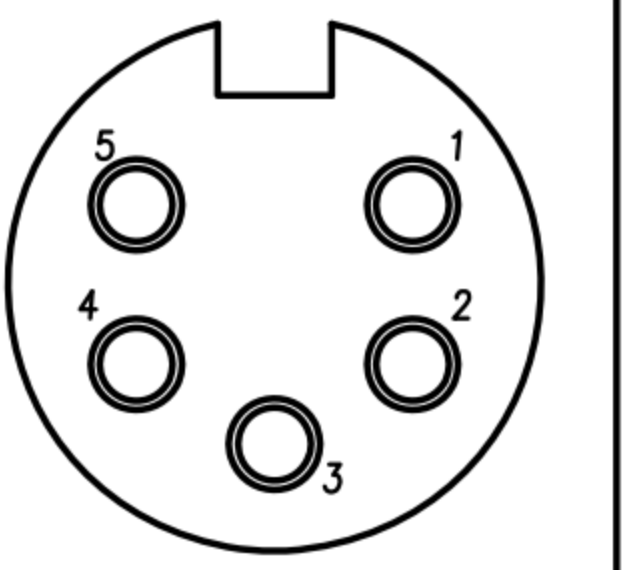
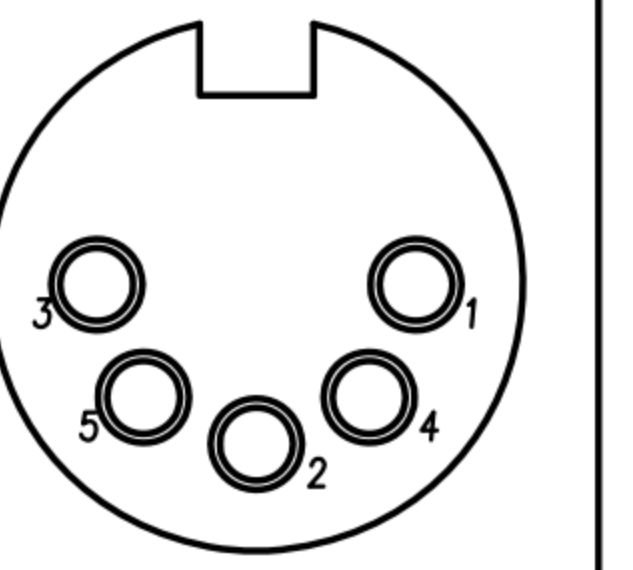
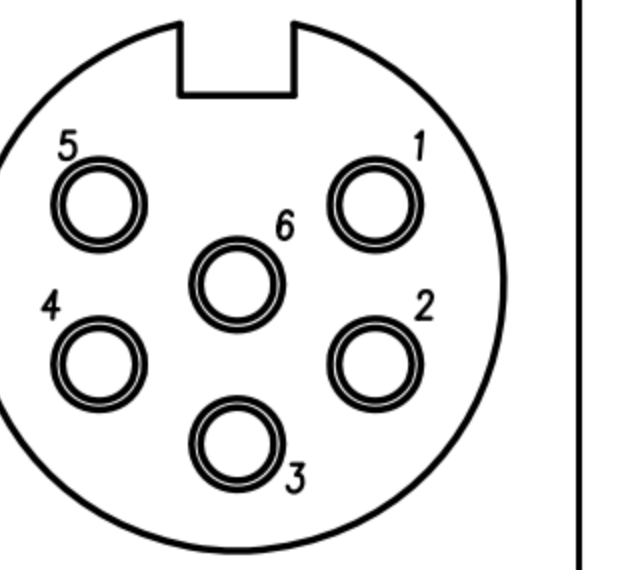
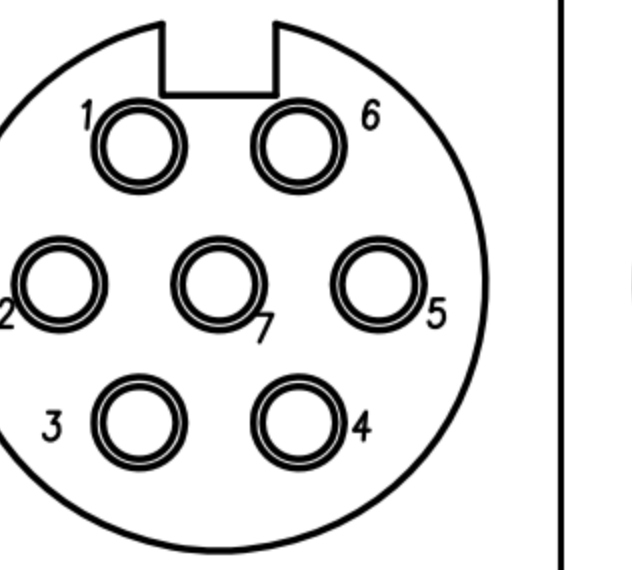
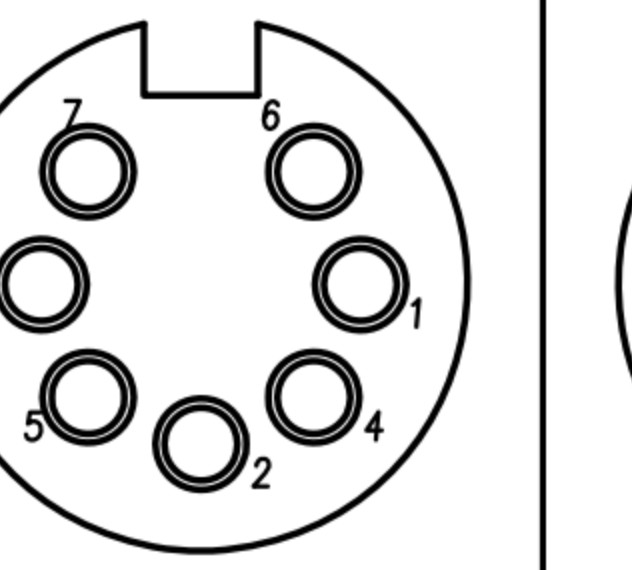
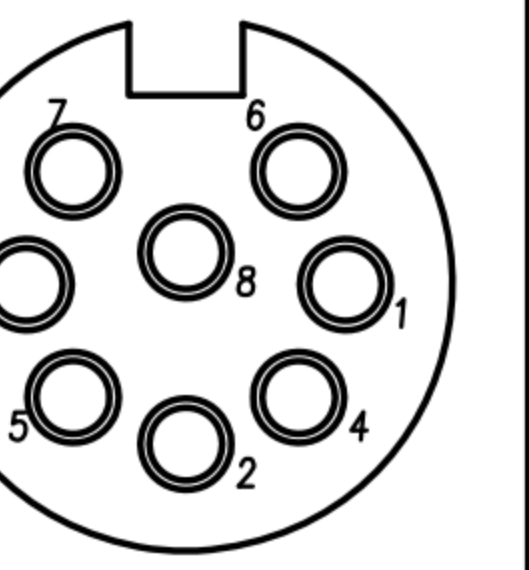
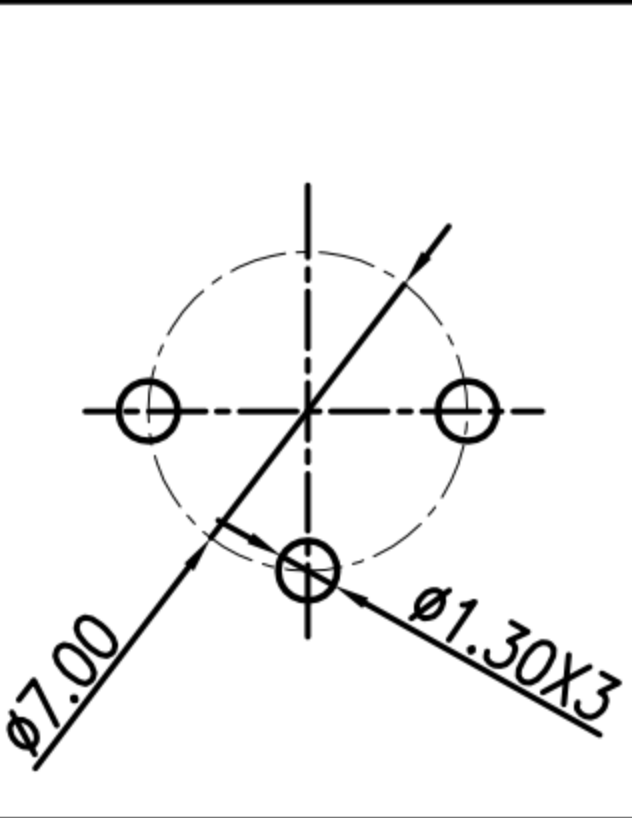
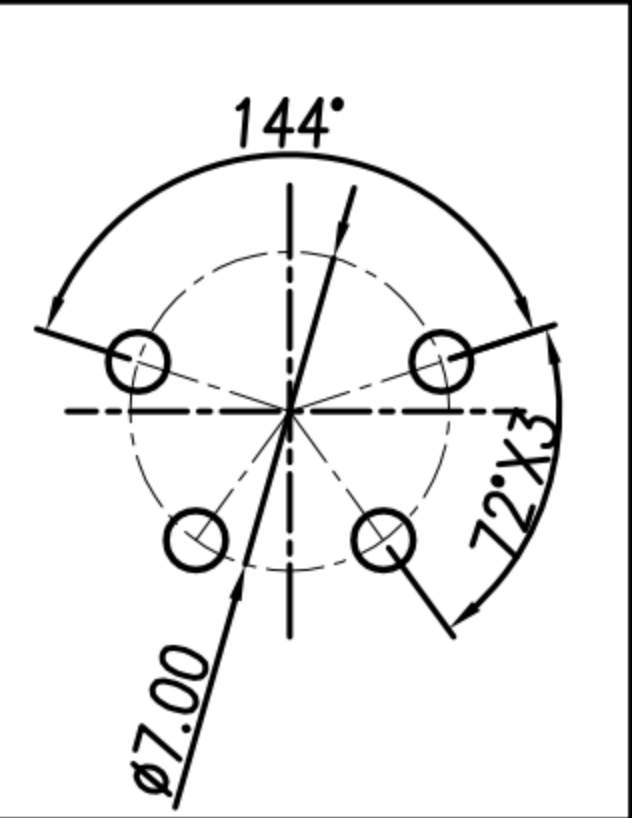
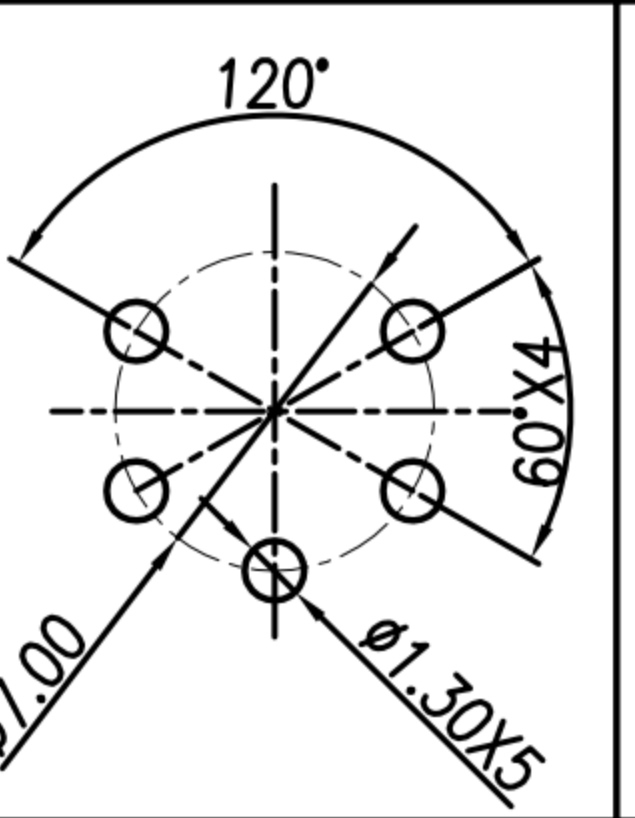
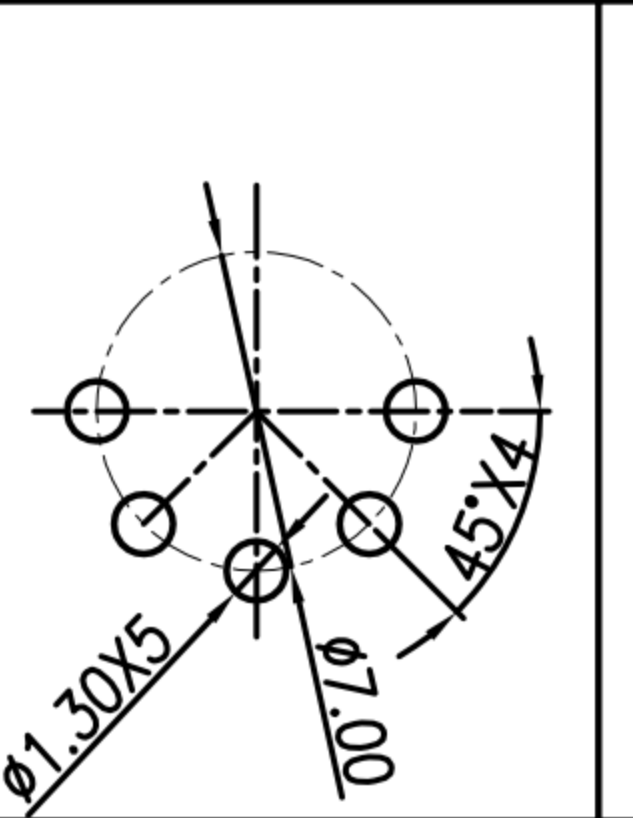
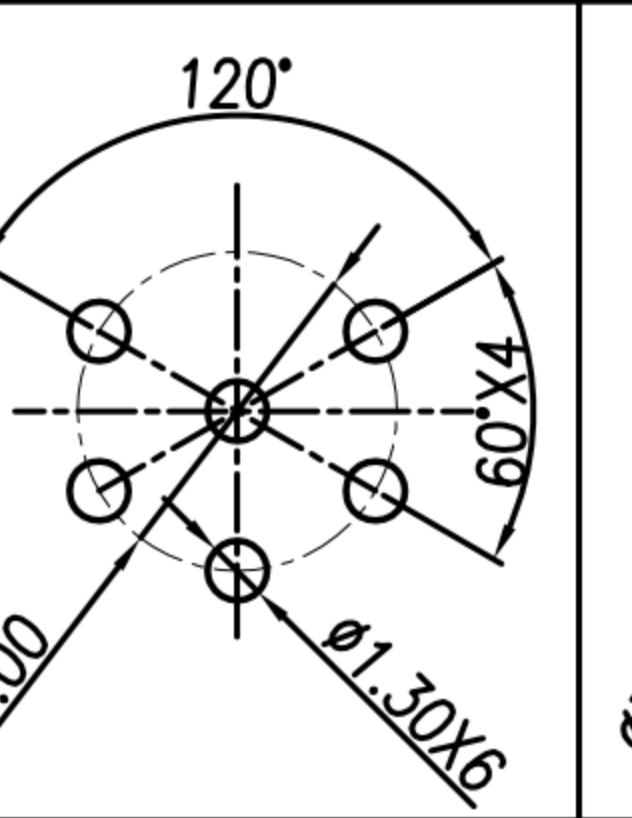
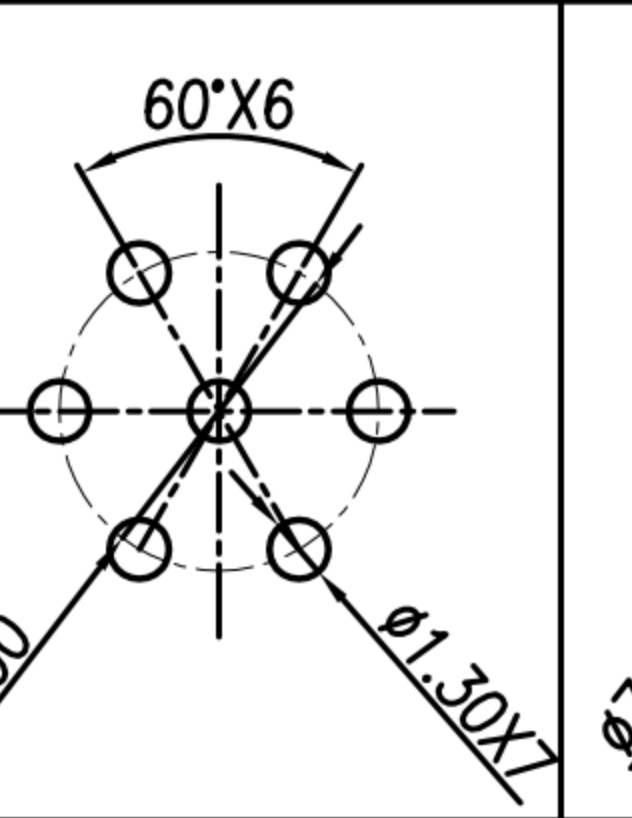
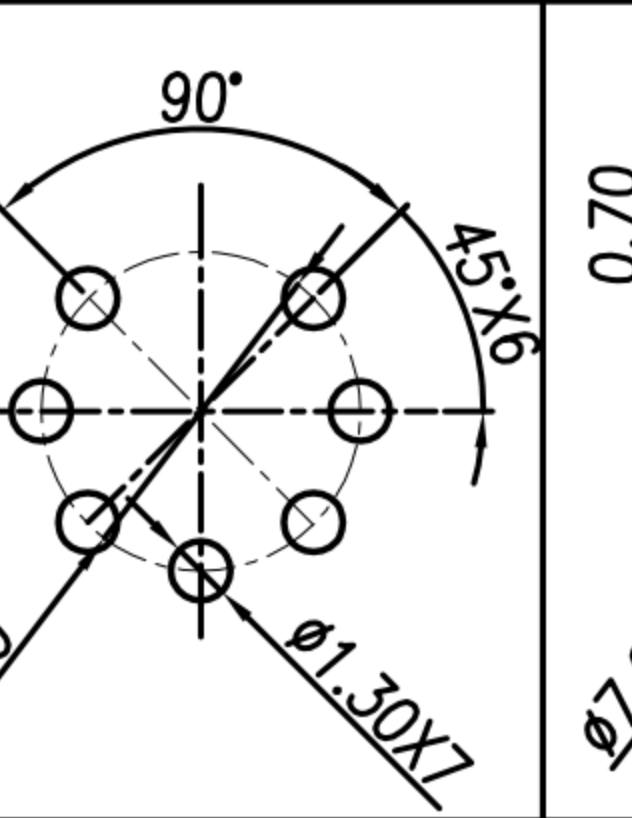
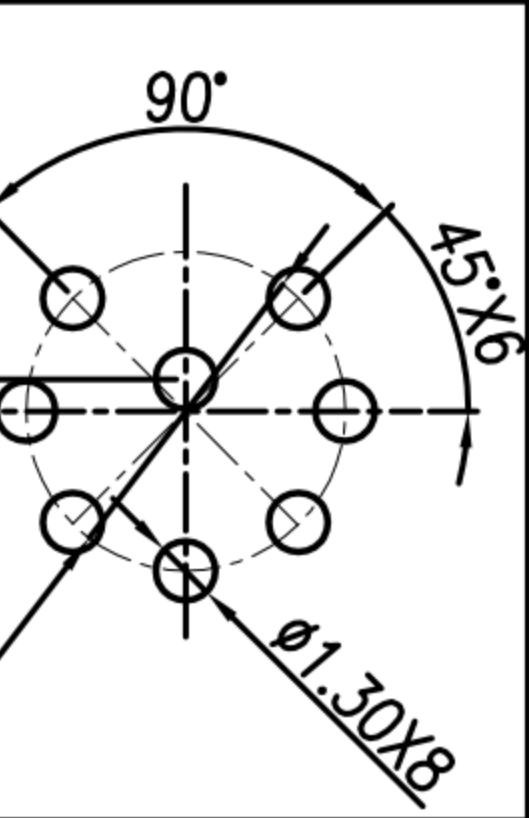

CUSTOMER DRAWING

REV.	DESCRIPTION	APPROVED BY	DATE	ECN NO.
A	RELEASE	EMILY SUEN	24/10/17'	
B	ADD P/N	KU CHOU	09/03/21'	
C				

TABLE A

							
3 PIN	4 PIN	5 PIN(5a)	5 PIN(5b)	6 PIN	7 PIN(7a)	7 PIN(7b)	8 PIN
							
WP-03F3-06-11	WP-04F3-18-11	WP-05F3-23-11	WP-05F3-21-11	WP-06F3-08-11	WP-07F3-03-11	WP-07F3-04-11	WP-08F3-02-11

PIN ASSIGNMENTS & PCB LAYOUT FRONT VIEW

DRAWN	Emily Suen	APP'D	Ku Chou	UNIT	mm	TOLERANCE		 广东科斯达电子科技有限公司 GUANG DONG KE SI DA ELECTRONIC TECHNOLOGY CO., LTD.	TITLE	DIN (F) 插M18 DIP			SHEET
CHK'D	Ku Chou			SCALE	1:1	.x ±0.20 .xx ±0.10 .xxx ±0.05 .xxxx ±0.03 ANGULAR ±1°			PART NO.	SEE TABLE A	DWG NO.	QC8283	VERSION

CUSTOMER DRAWING

REV.	DESCRIPTION	APPROVED BY	DATE	ECN NO.
A	RELEASE	EMILY SUEN	24/10/17'	
B	ADD P/N	KU CHOU	09/03/21'	
C				

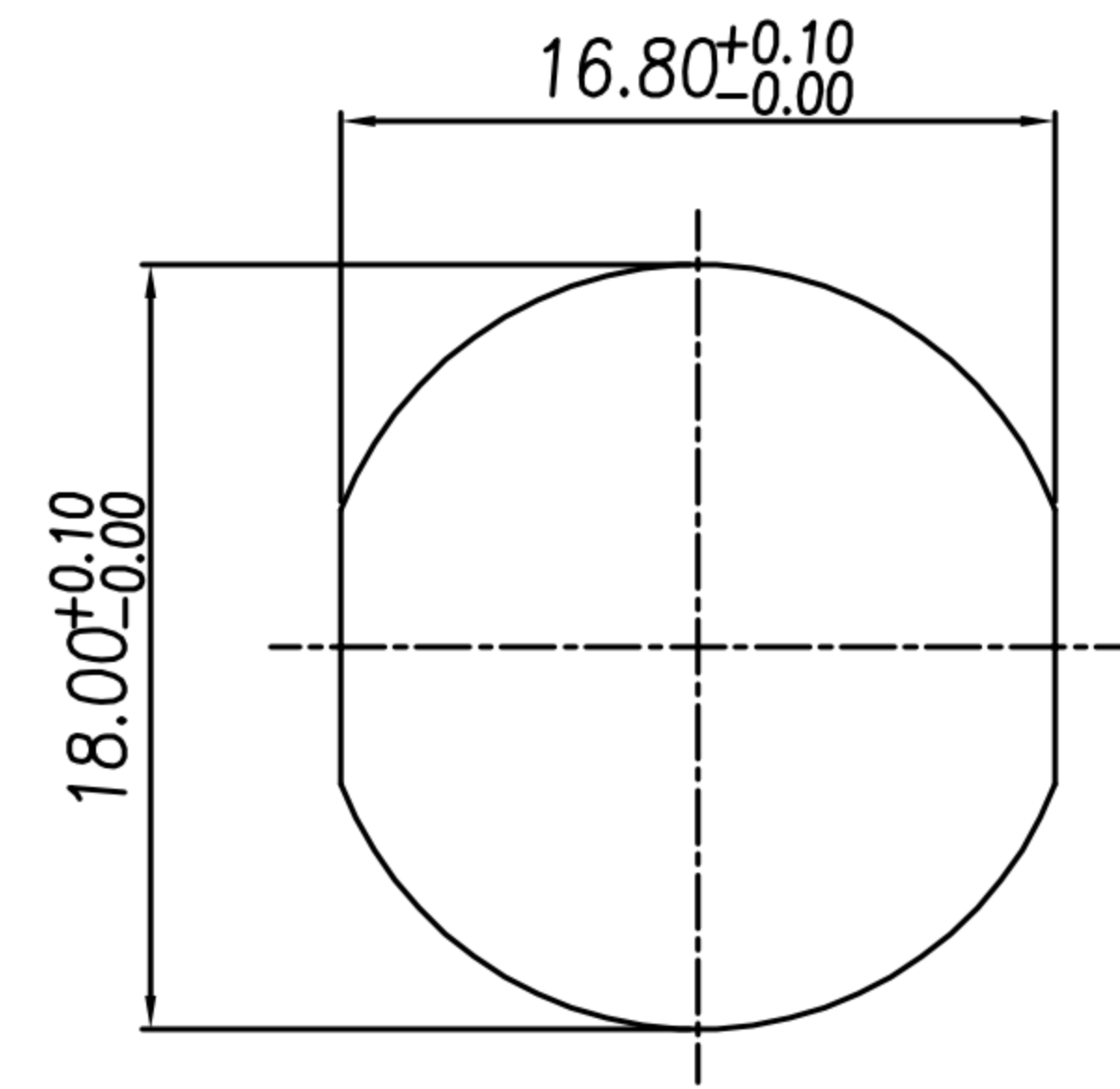
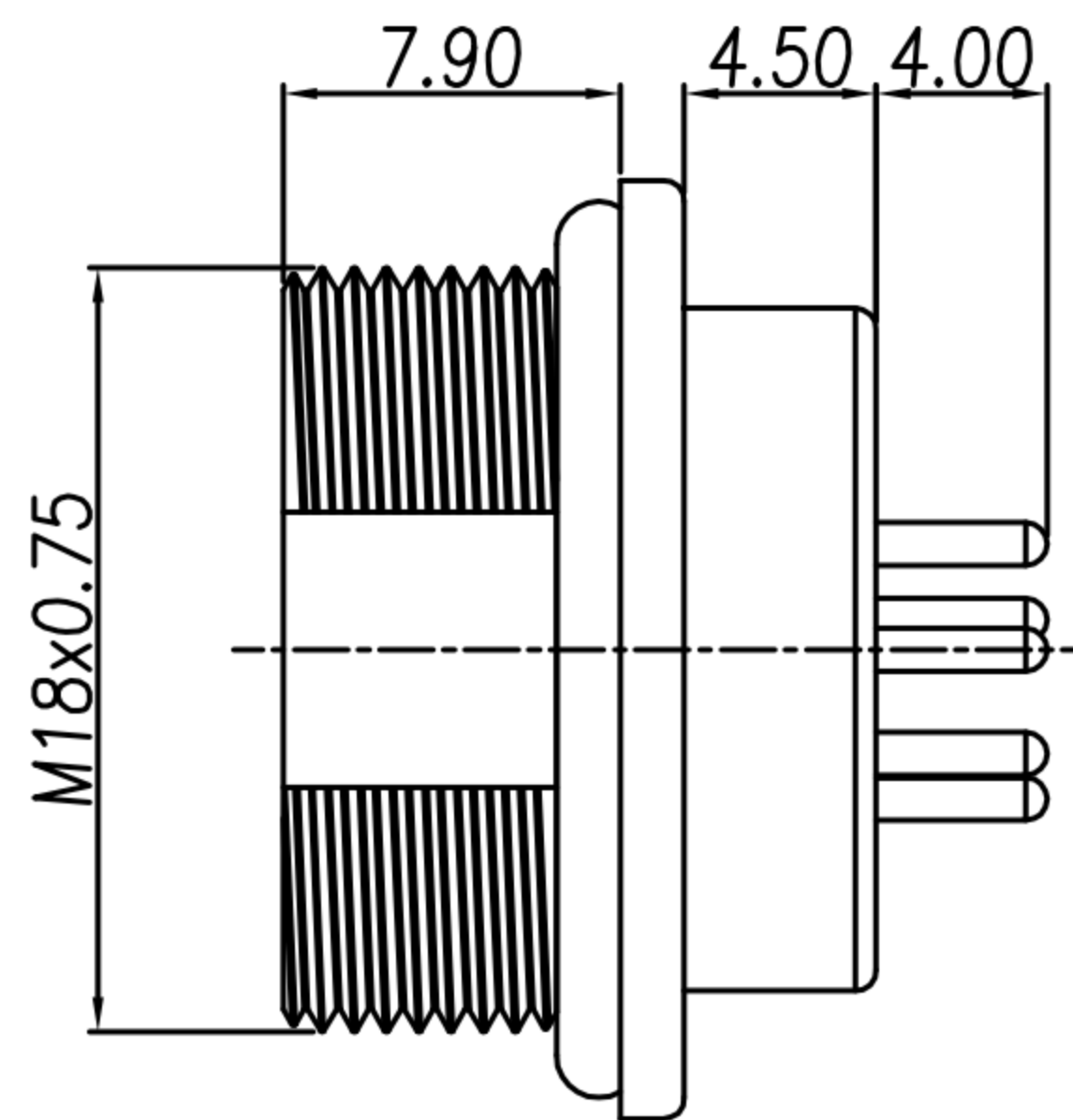
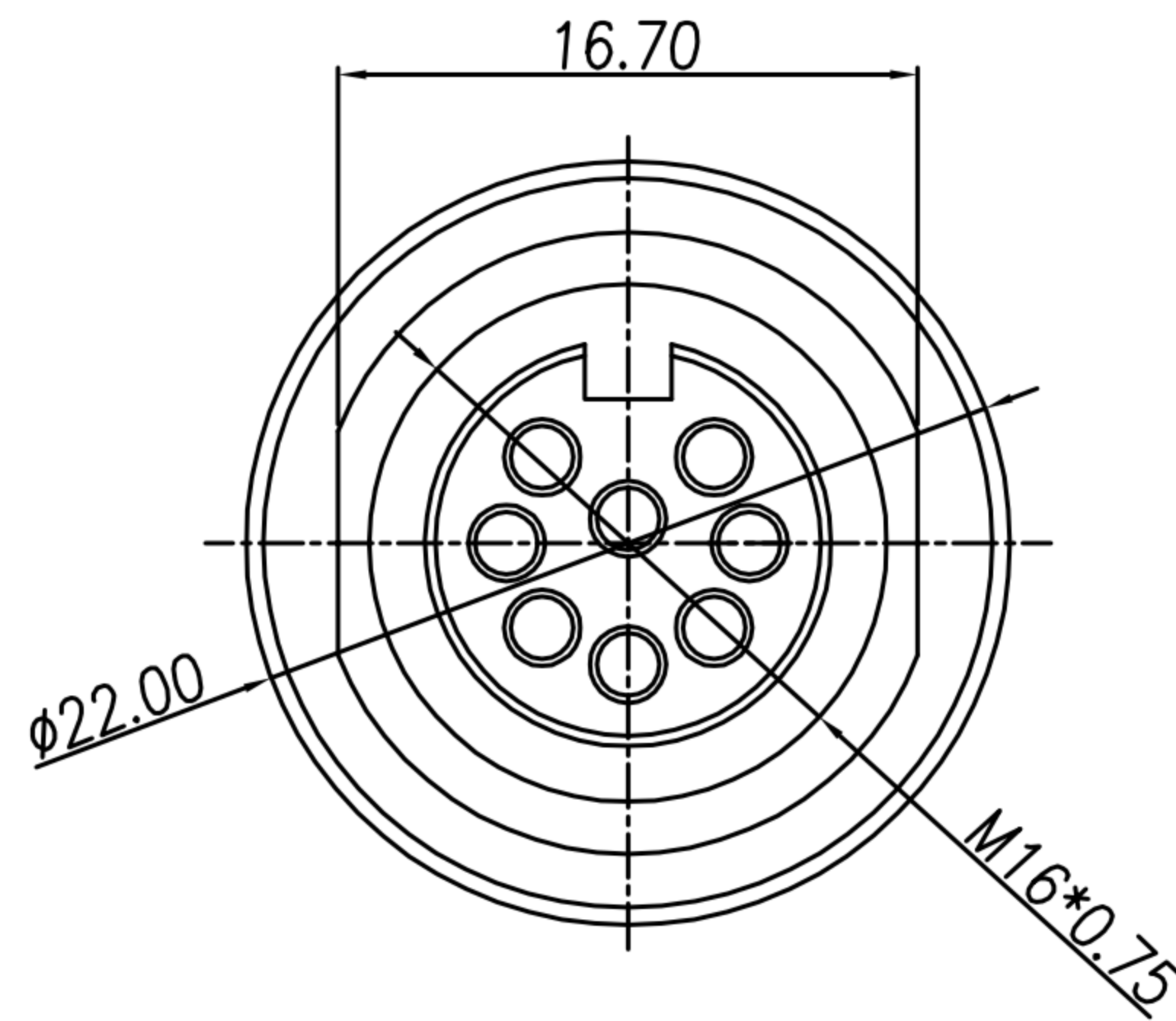

RECOMMEND PANEL CUT-OUT

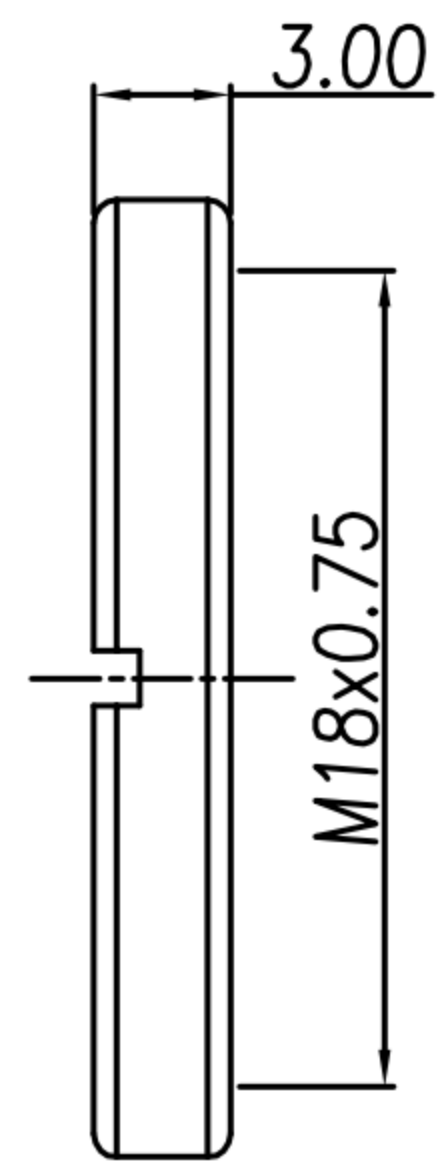
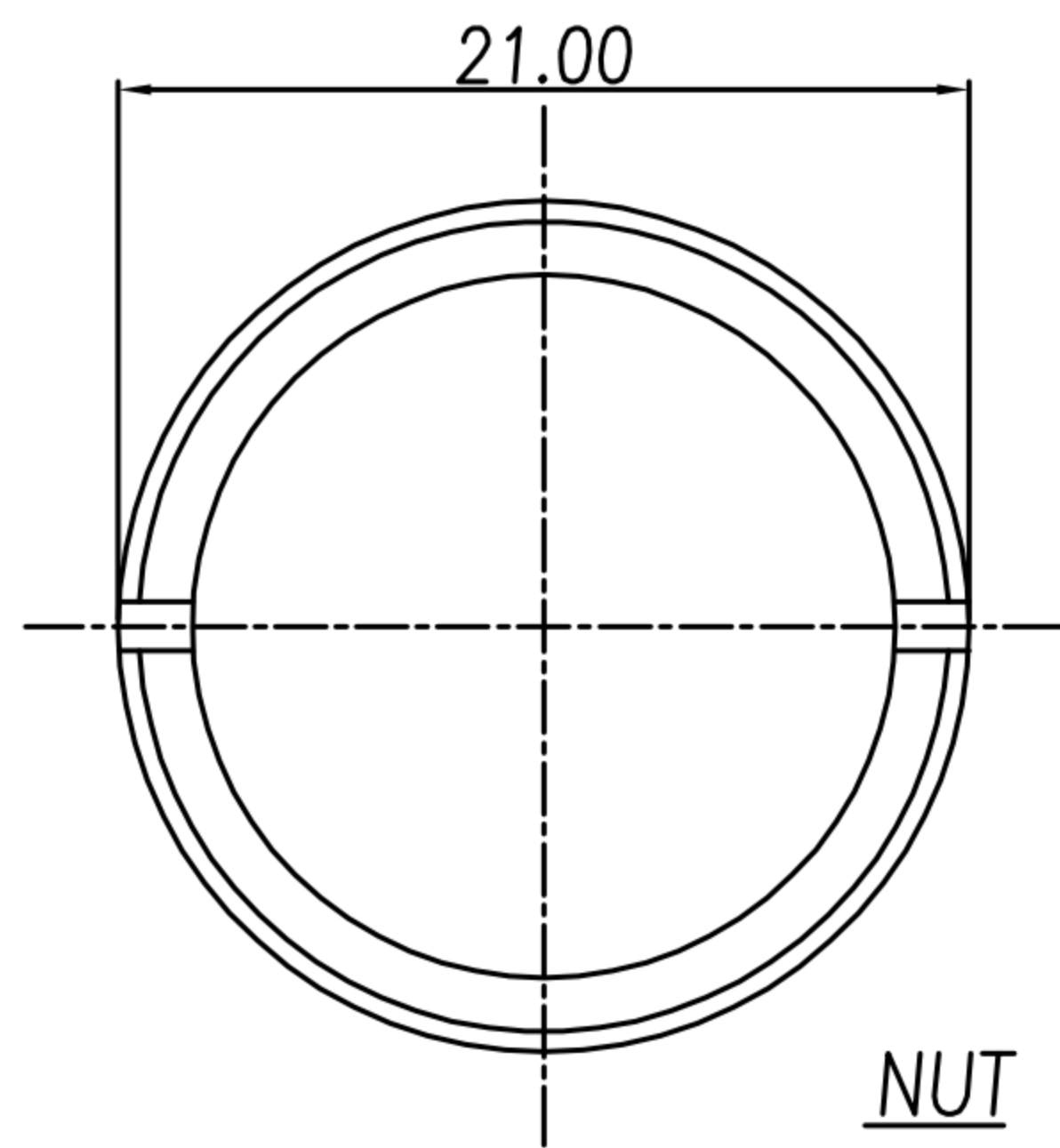

NUT

1. MATERIAL :
 - 1-1. HOUSING : PA66 UL94V-0 ; COLOR : BLACK
 - 1-2. CONTACT : BRASS
 - 1-3. SHELL : BRASS
 - 1-4. O-RING : EPDM ; COLOR : BLACK
 - 1-5. NUT : BRASS
2. FINISH :
 - 2-1. CONTACT : GOLD FLASH
UNDER PLATE : NICKEL
 - 2-2. NUT : NICKEL PLATED
 - 2-3. SHELL : NICKEL PLATED
 - 2-4. NUT : NICKEL PLATED
3. ELECTRICAL SPECIFICATION :
 - 3-1. RATED CURRENT: 5A
 - 3-2. RATED VOLTAGE : 250V
 - 3-3. WATER PROOF: IP67
4. ENVIRONMENTAL :
 - 4-1. OPERATION TEMPERATURE : -40℃~85℃

DRAWN	Emily Suen	APP'D	Ku Chou	UNIT	mm	TOLERANCE		广东科斯达电子科技有限公司 GUANG DONG KE SI DA ELECTRONIC TECHNOLOGY CO., LTD.	TITLE	DIN (F) 插M18 DIP			SHEET
CHK'D	Ku Chou			SCALE	1:1	.x ±0.20 .xx ±0.10 .xxx ±0.05 .xxxx ±0.03 ANGULAR ±1°			PART NO.	SEE TABLE A	DWG NO.	QC8283	VERSION