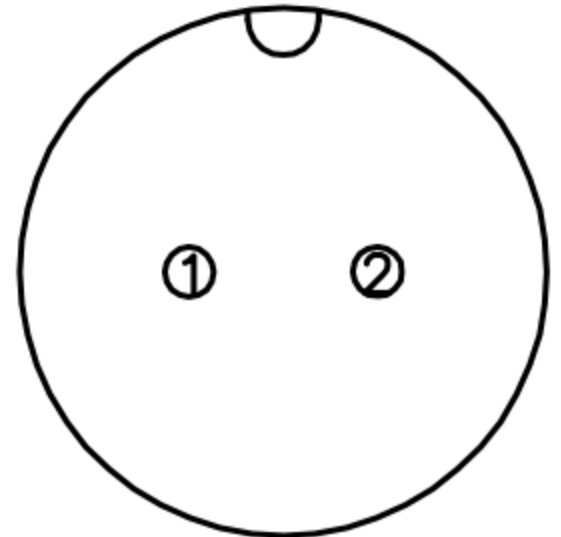
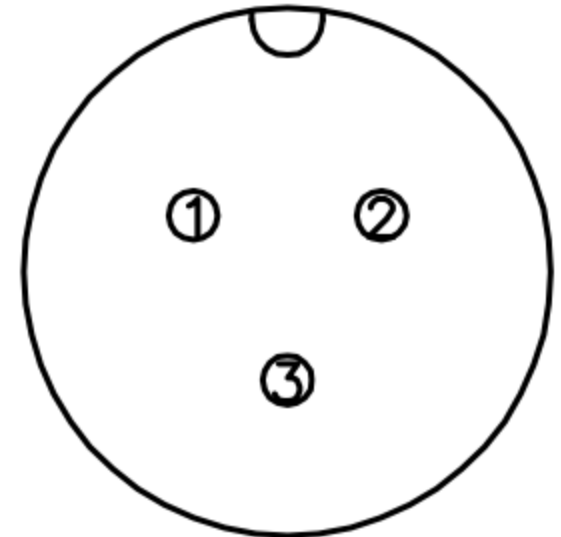
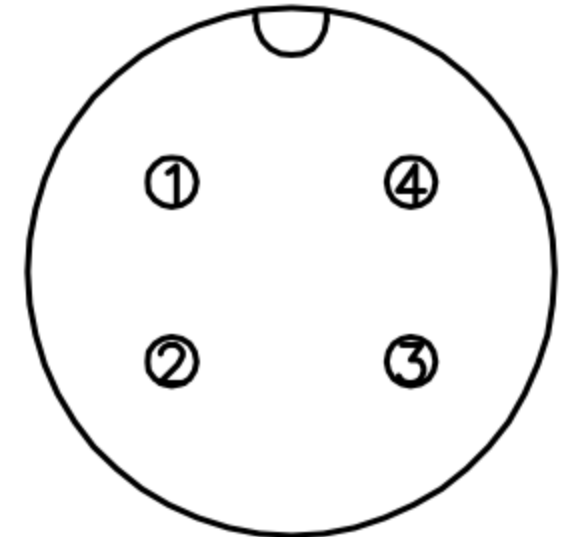
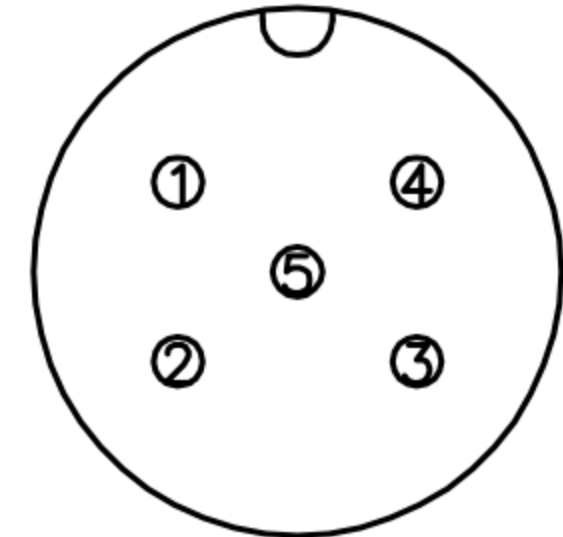
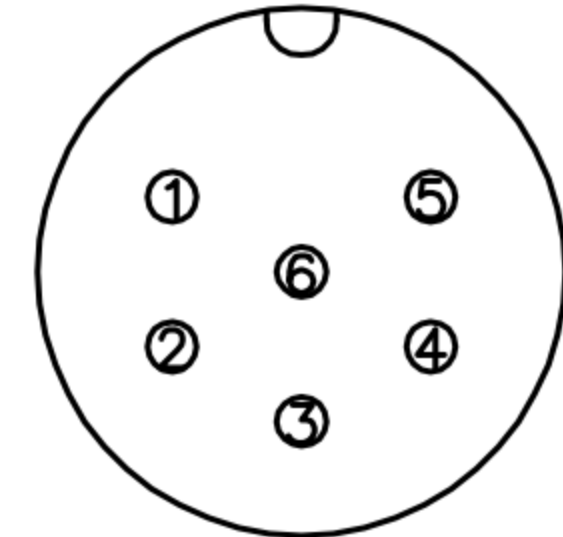
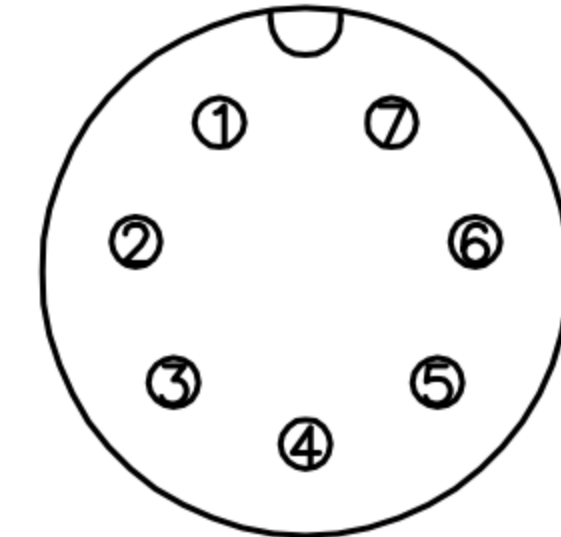
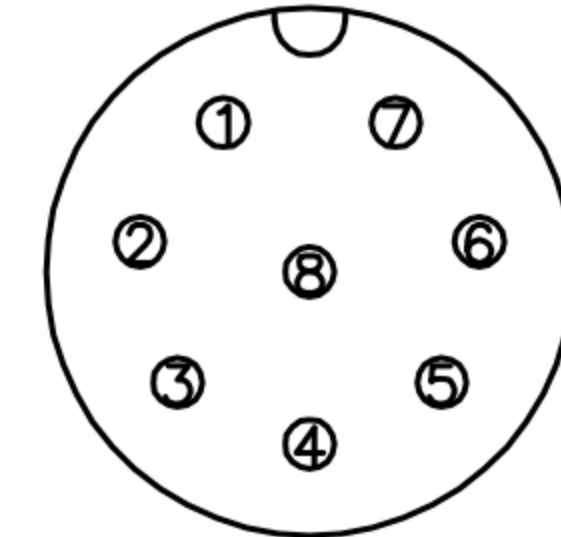

This document is the property of Nian-Yeong Corporation and is delivered on the express condition that it is not to be disclosed, reproduced or used, in whole or in part, for manufacture or sale by anyone other than Nian-Yeong Corporation without its prior consent, and that no right is granted to disclose or to use any information in this document.

CUSTOMER DRAWING

REV.	DESCRIPTION	APPROVED BY	DATE	ECN NO.
A	RELEASE	Ku Chou	25/06/18'	
B				
C				

TABLE A

						
2 PIN	3 PIN	4 PIN	5 PIN	6 PIN	7 PIN	8 PIN
WP-02M3-03-11	WP-03M3-02-11	WP-04M3-04-11	WP-05M3-06-11	WP-06M3-04-11	WP-07M3-01-11	WP-08M3-02-11

PIN ASSIGMENTS  
FRONT VIEW

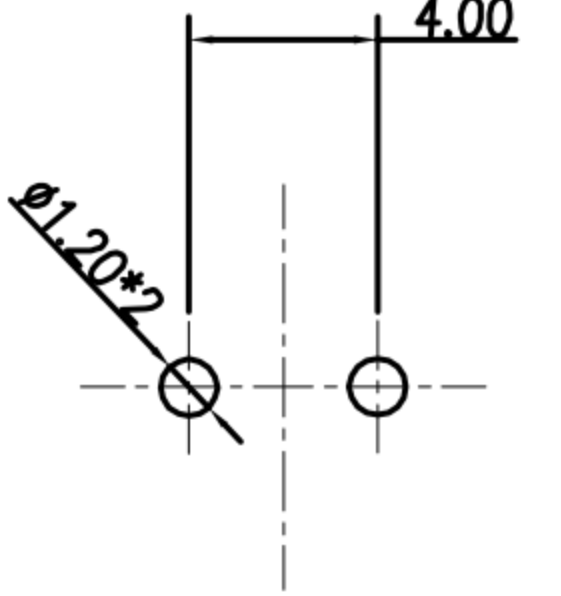
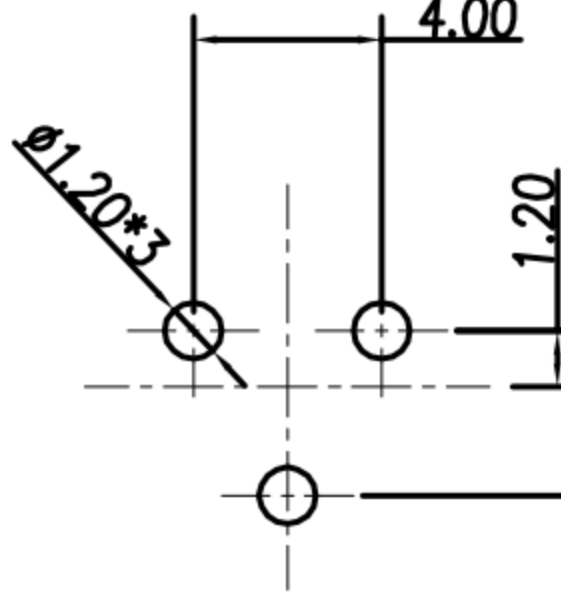
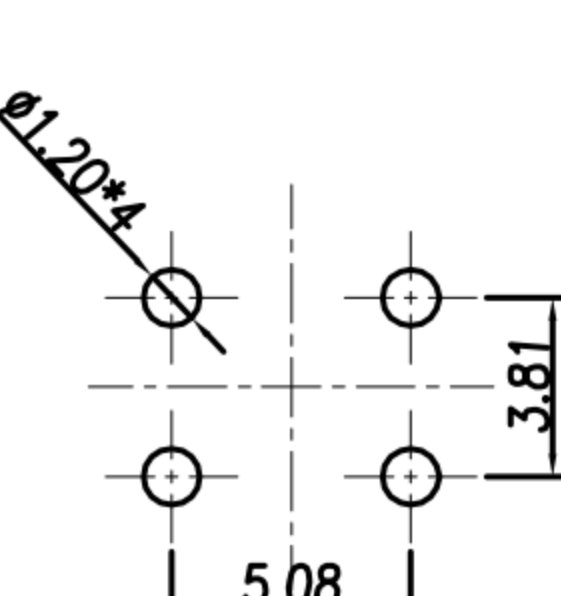
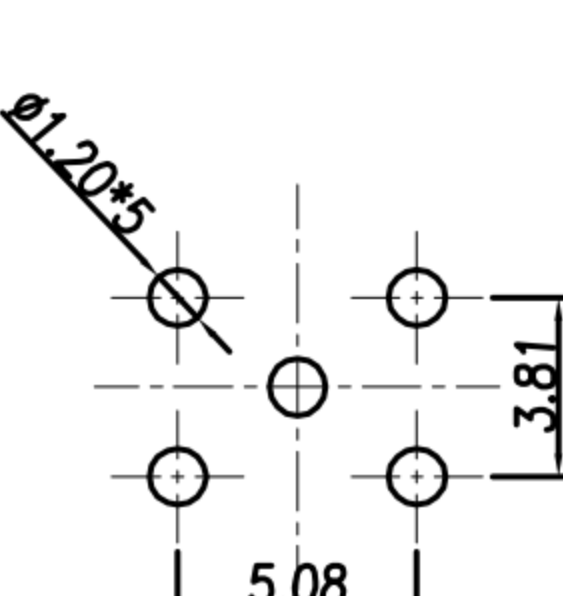
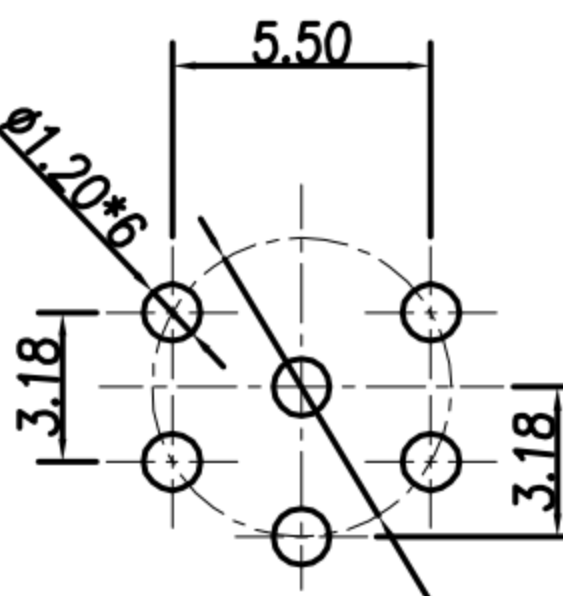
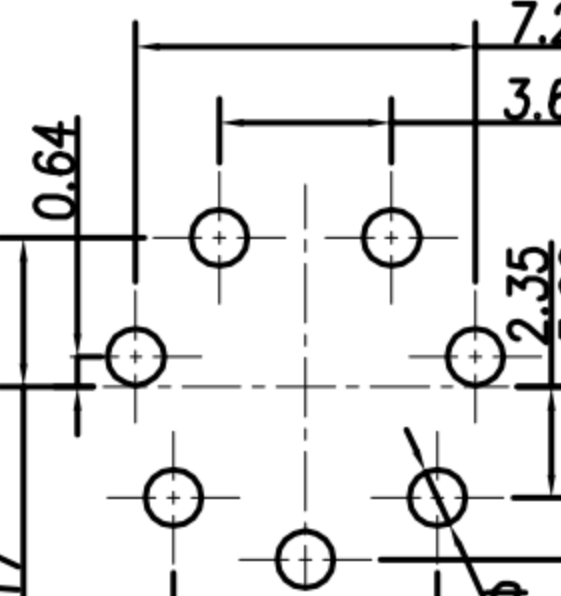
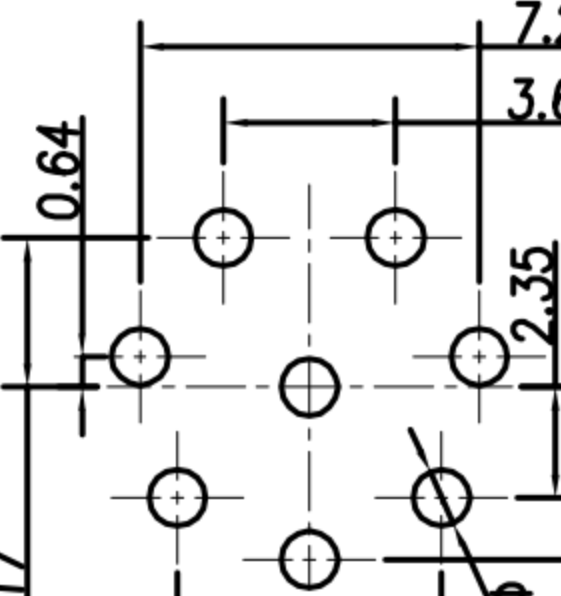
						
2 PIN	3 PIN	4 PIN	5 PIN	6 PIN	7 PIN	8 PIN

PCB LAYOUT

DRAWN	Emily Suen	APP'D	Ku Chou	UNIT	mm	TOLERANCE		 <b>广东科斯达电子科技有限公司</b> GUANG DONG KE SI DA ELECTRONIC TECHNOLOGY CO., LTD.	TITLE	WP (M) (LOCK) B SIZE 前鎖DIP式			SHEET	2/2
CHK'D	Ku Chou			SCALE	1:1	.x ±0.20 .xx ±0.10 .xxx ±0.05 .xxxx ±0.03 ANGULA ±1°			PART NO.	SEE TABLE A	DWG NO.	QC8435	VERSION	A

CUSTOMER DRAWING

REV.	DESCRIPTION	APPROVED BY	DATE	ECN NO.
A	RELEASE	Ku Chou	25/06/18'	
B				
C				

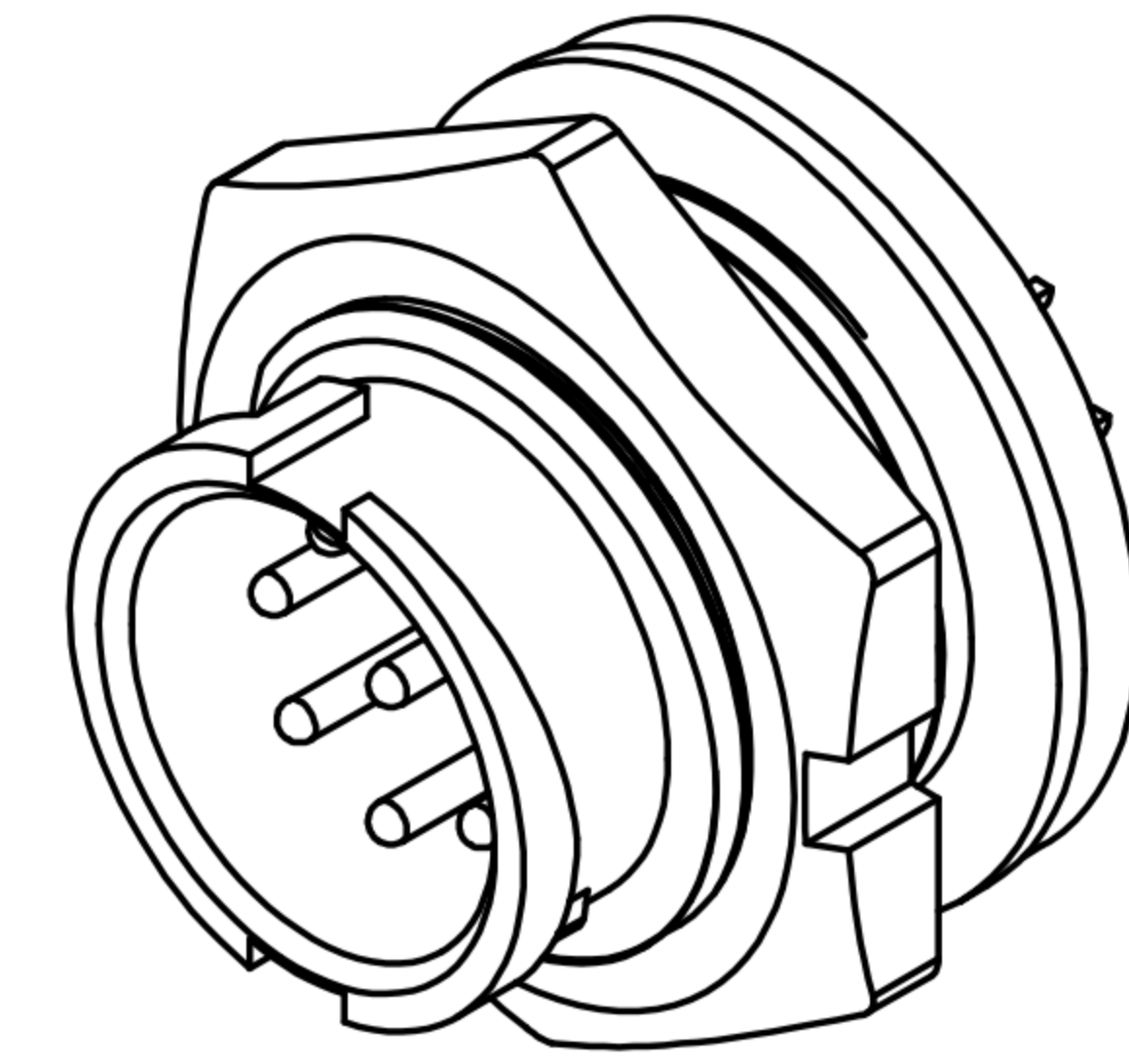
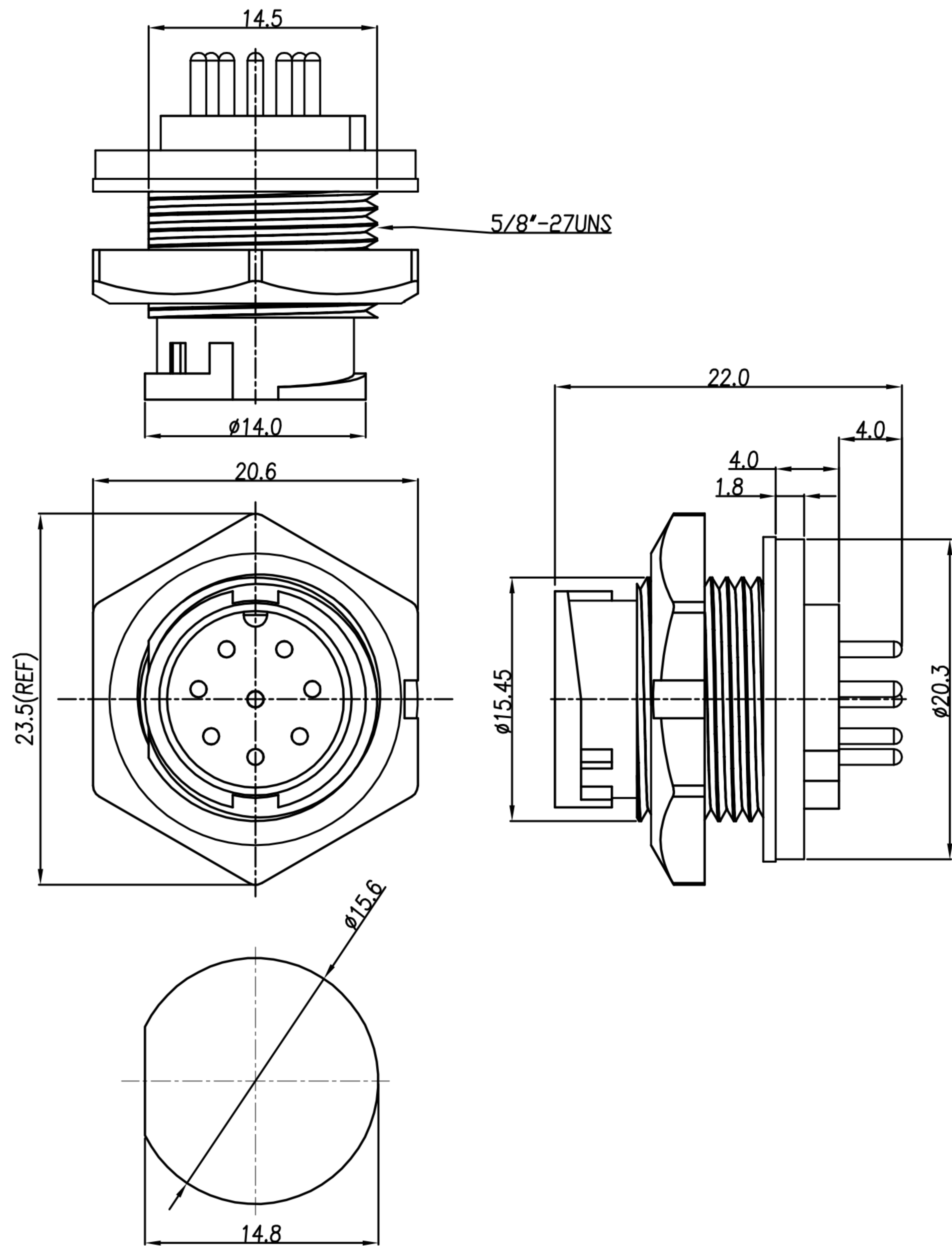

- MATERIAL :
  - 1-1. HOUSING : PA66
  - 1-2. CONTACT : BRASS
  - 1-3. GASKET : SILICONE
  - 1-4. HEX NUT : PA66
- FINISH :
  - 2-1. CONTACT : GOLD FLASH PLATED.
- ELECTRICAL SPECIFICATION :
  - 3-1. Rated current : 5A
  - 3-2. Rated voltage : 250V
  - 3-3. Water proof : IP67
- Environmental :
  - 4-1. Operation Temperature : -40℃~105℃

RECOMMENDED PANEL CUT-OUT

DRAWN	Emily Suen	APP'D	Ku Chou	UNIT	mm	TOLERANCE		广东科斯达电子科技有限公司 GUANG DONG KE SI DA ELECTRONIC TECHNOLOGY CO., LTD.	TITLE	WP (M) (LOCK) B SIZE 前鎖DIP式			SHEET	1/2
CHK'D	Ku Chou			SCALE	1:1	.x ±0.20 .xx ±0.10 .xxx ±0.05 .xxxx ±0.03 ANGULA ±1°			PART NO.	SEE TABLE A	DWG NO.	QC8435	VERSION	A