

CUSTOMER DRAWING

TABLE A

REV.	DESCRIPTION	APPROVED BY	DATE	ECN NO.
A	RELEASE	KU Chou	02/05/18*	
B	ADD PART NO.	Emily Suen	09/07/18*	
C				
D				

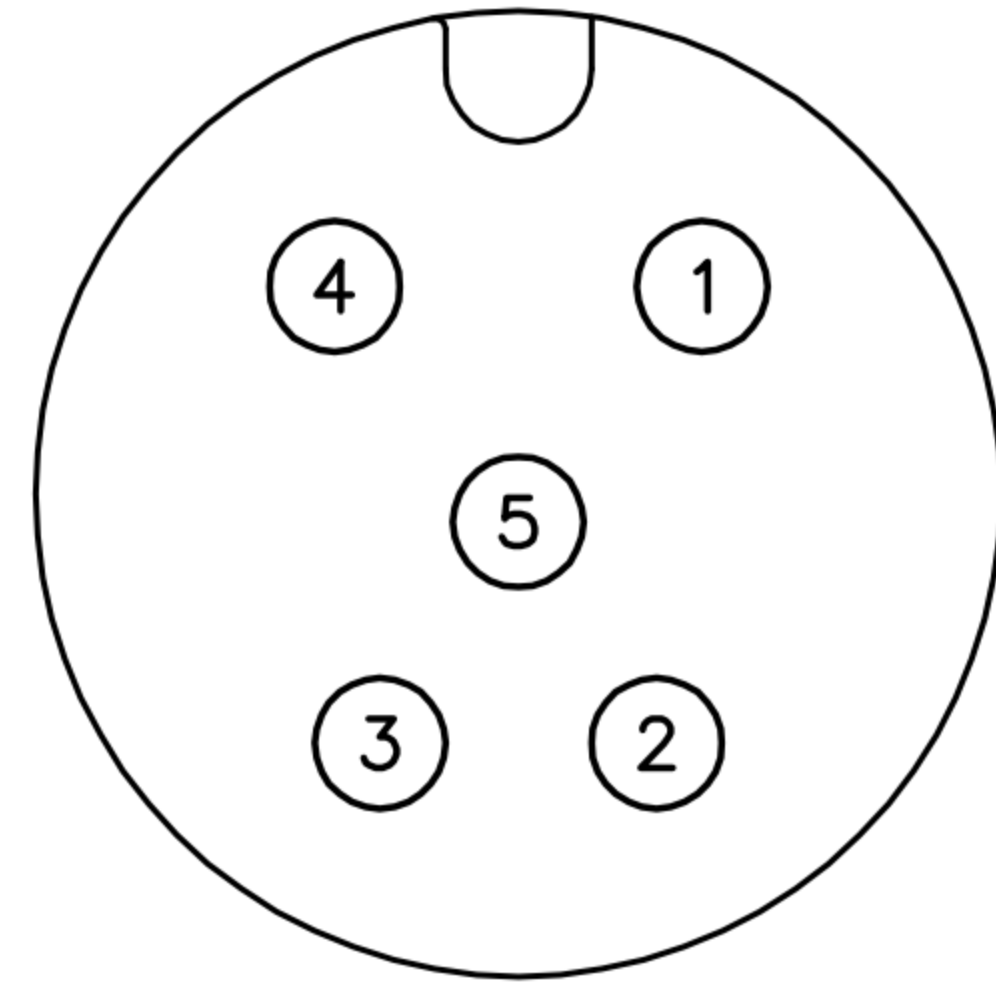

5P

WP-05F2-148-11

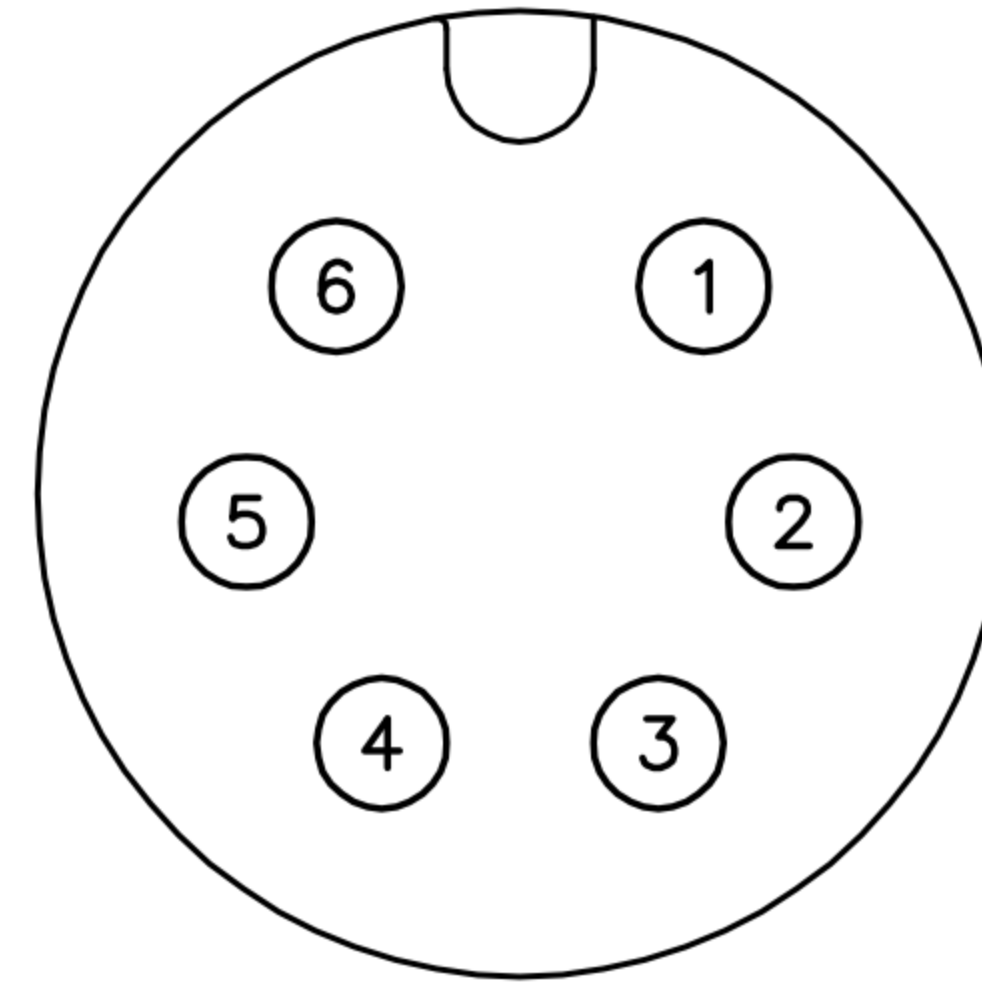

6P

WP-06F2-76-11

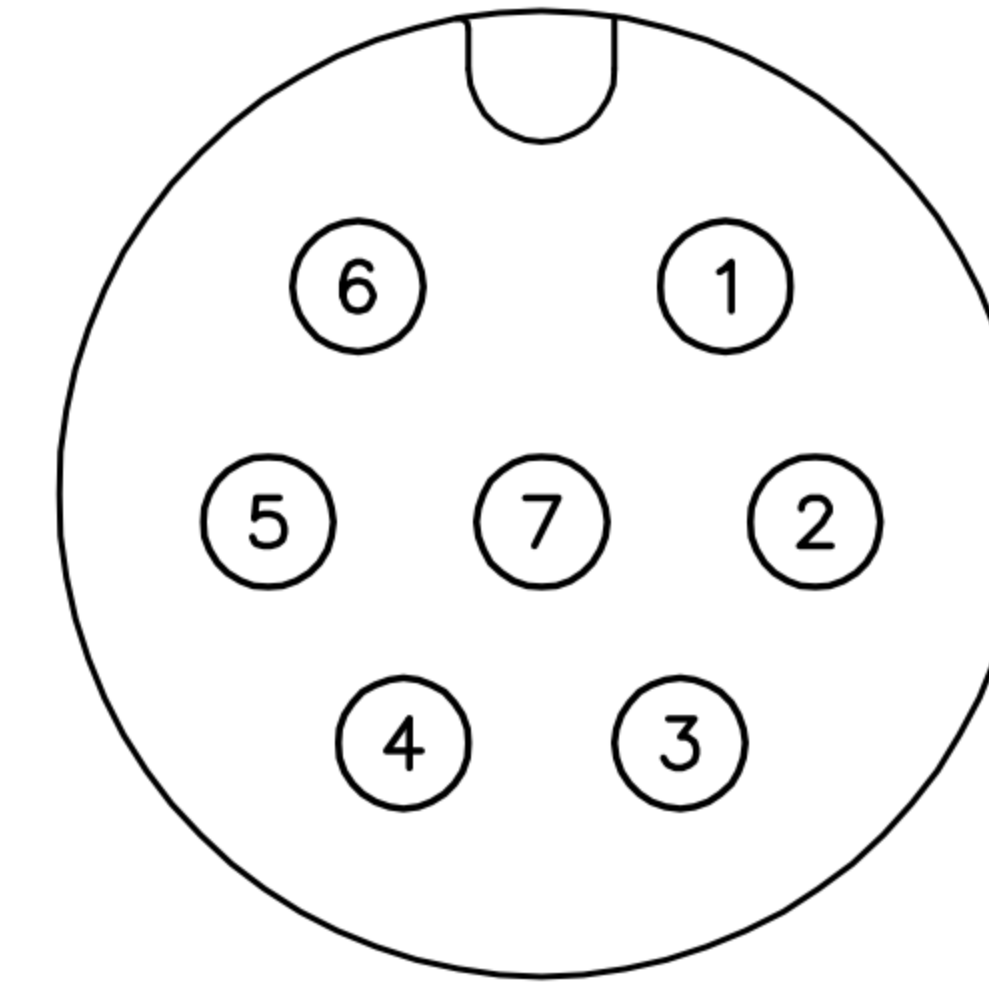

7P

WP-07F2-07-11

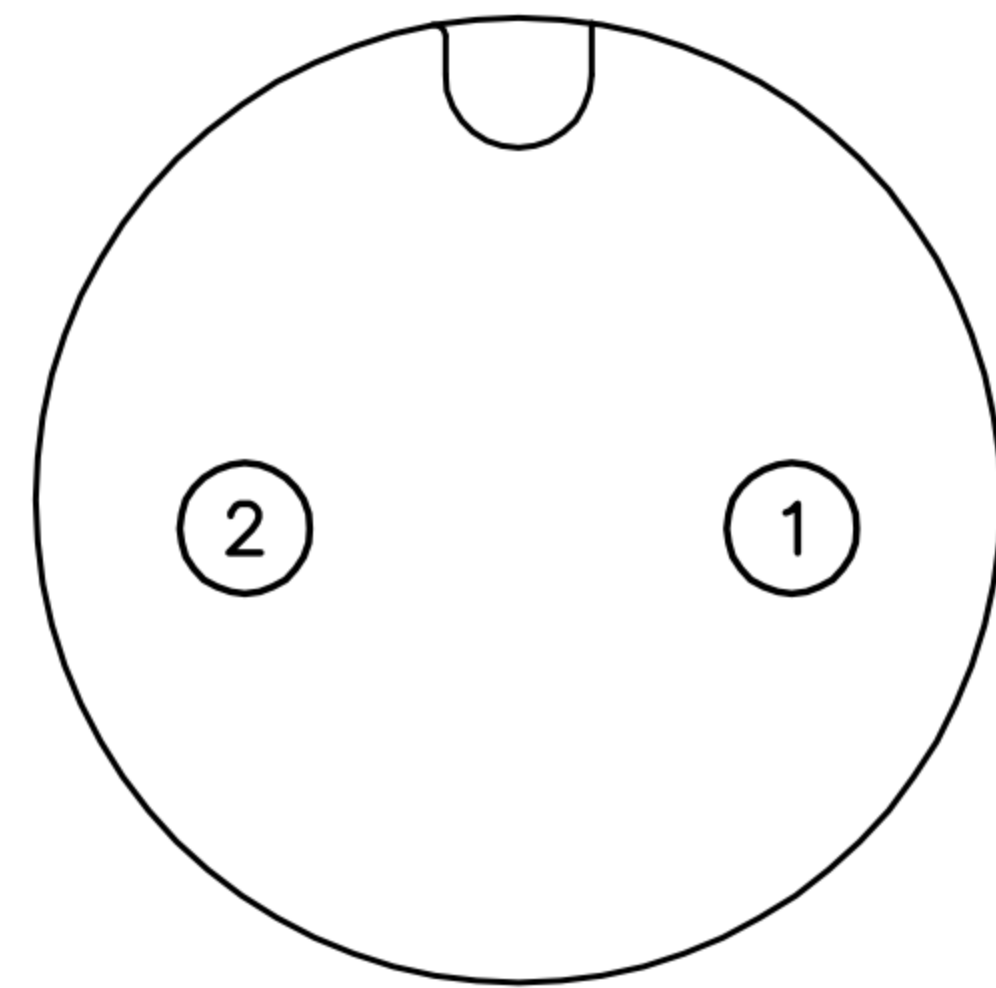

2P

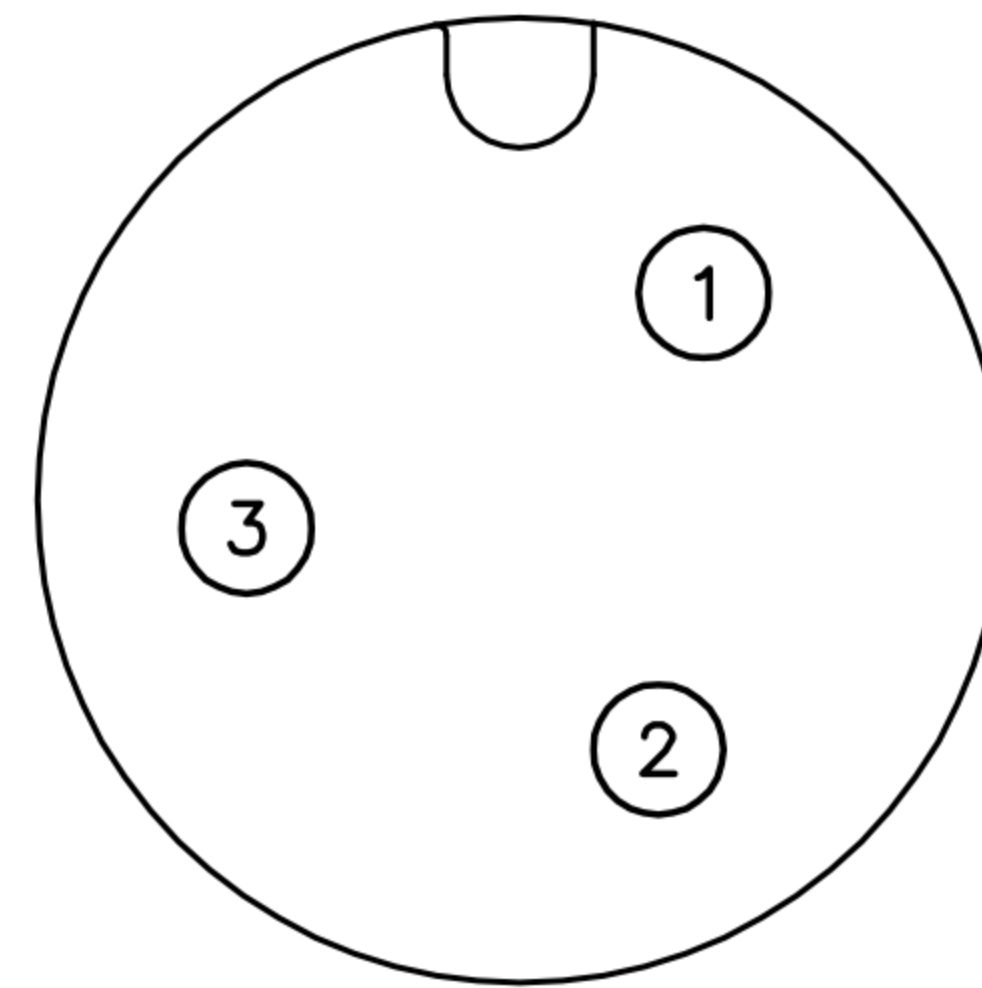

3P

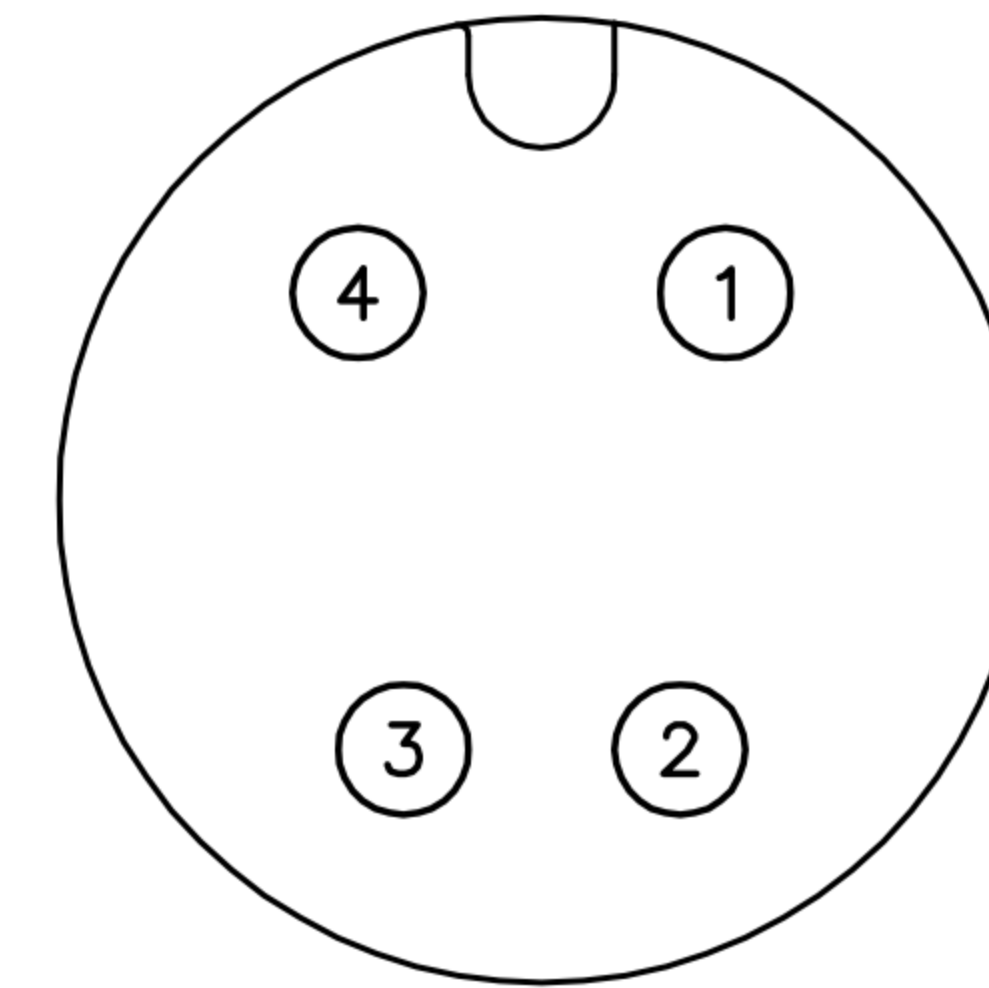

4P

WP-04F2-205-11

PIN CONFIGURATION

DRAWN	Yeh Chou	APP'D	KU Chou	UNIT	mm	TOLERANCE		广东科斯达电子科技有限公司 GUANG DONG KE SI DA ELECTRONIC TECHNOLOGY CO., LTD.	TITLE	D SIZE (FEMALE PIN) 20A			SHEET
CHK'D	KU Chou			SCALE	1:1	.x ±0.20 .xx ±0.10 .xxx ±0.05 .xxxx ±0.03 ANGULA ±1°			PART NO.	SEE TABLE A	DWG NO.	QC8384	2 2

CUSTOMER DRAWING

REV.	DESCRIPTION	APPROVED BY	DATE	ECN NO.
A	RELEASE	KU Chou	02/05/18*	
B	ADD PART NO.	Emily Suen	09/07/18*	
C				
D				

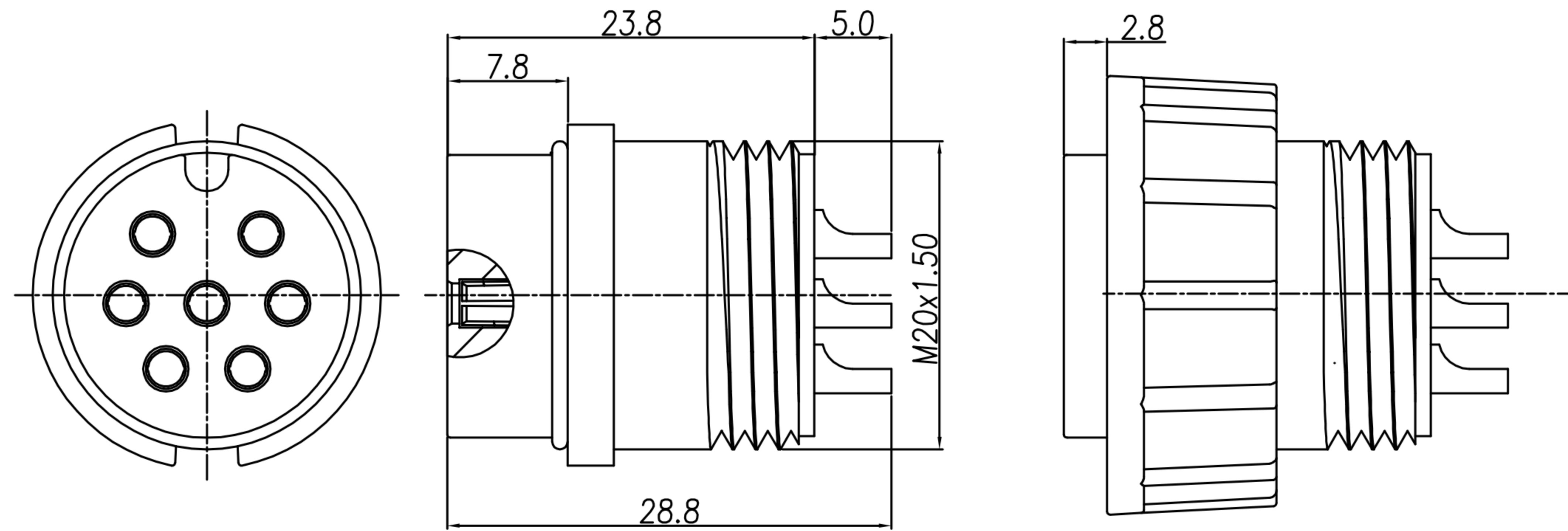

ASS'Y

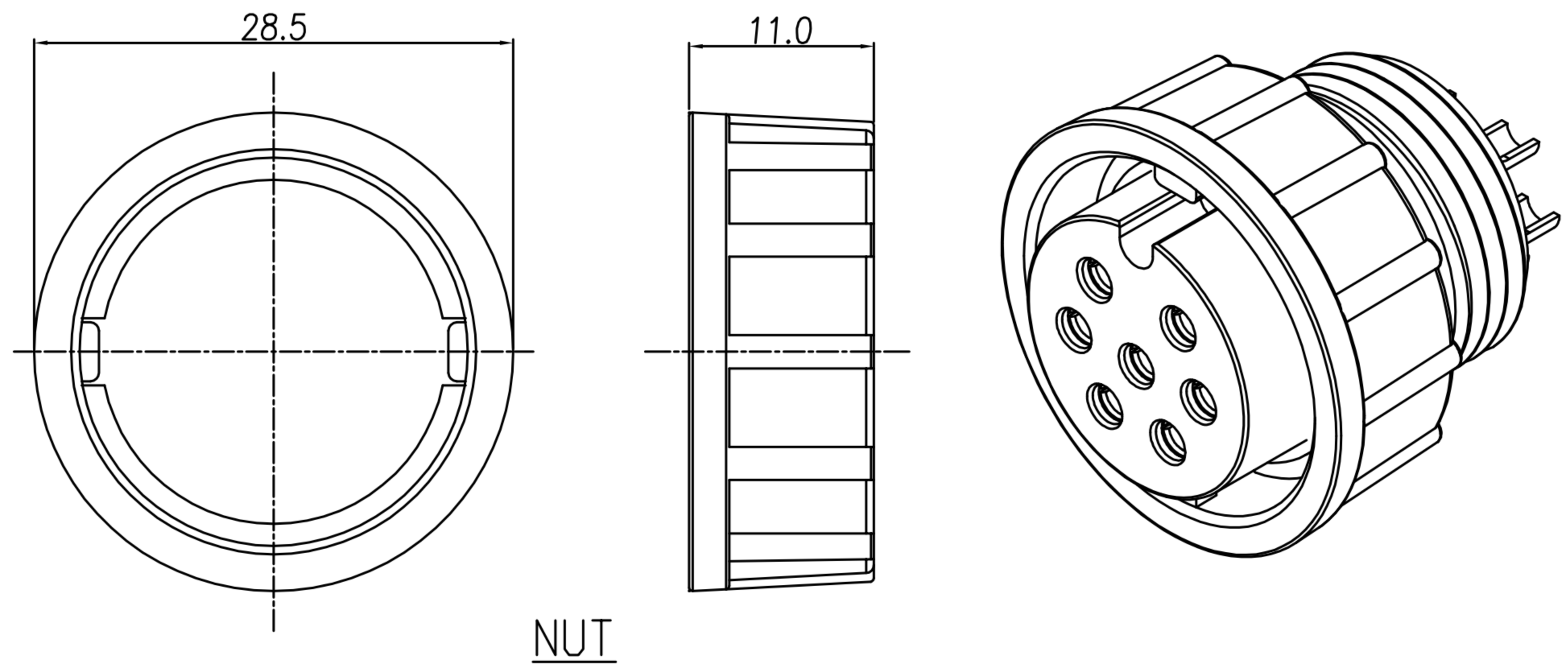

NUT

1. MATERIAL :
 - 1-1. HOUSING : PA66
 - 1-2. CONTACT : BRASS
 - 1-3. O-RING : SILICONE
 - 1-4. NUT : PA66
2. FINISH :
 - 2-1. CONTACT : GOLD FLASH PLATED
3. ELECTRICAL SPECIFICATION :
 - 3-1. Rated current : 20A
 - 3-2. Rated Voltage : 300V
4. Environmental :
 - 4-1. Operation Temperature : -20℃~80℃

DRAWN	Yeh Chou	APP'D	KU Chou	UNIT	mm	TOLERANCE		广东科斯达电子科技有限公司 GUANG DONG KE SI DA ELECTRONIC TECHNOLOGY CO., LTD.	TITLE	D SIZE (FEMALE PIN) 20A			SHEET	1/2
CHK'D	KU Chou			SCALE	1:1	.x ±0.20 .xx ±0.10 .xxx ±0.05 .xxxx ±0.03 ANGULA ±1°			PART NO.	SEE TABLE A	DWG NO.	QC8384	VERSION	B