

CUSTOMER DRAWING

REV.	DESCRIPTION	APPROVED BY	DATE	ECN NO.
△A	RELEASE	Ku Chou	30/11/18'	
△B	CHANGE RATED VOLTAGE	Ku Chou	13/12/18'	
△C				

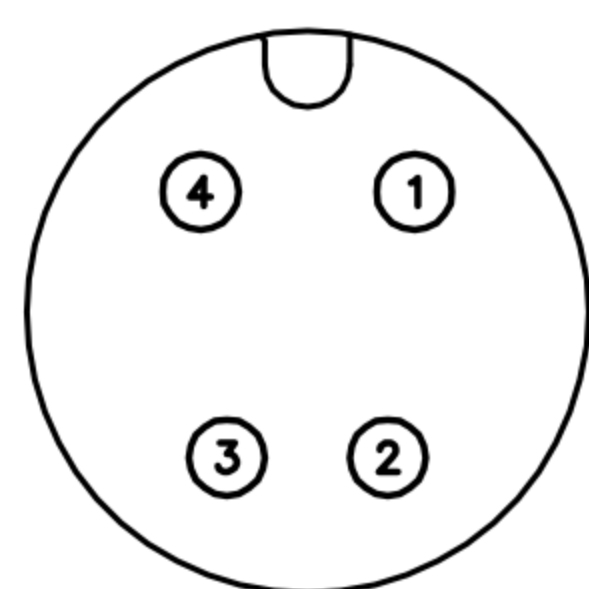

WP-04F2-206-11

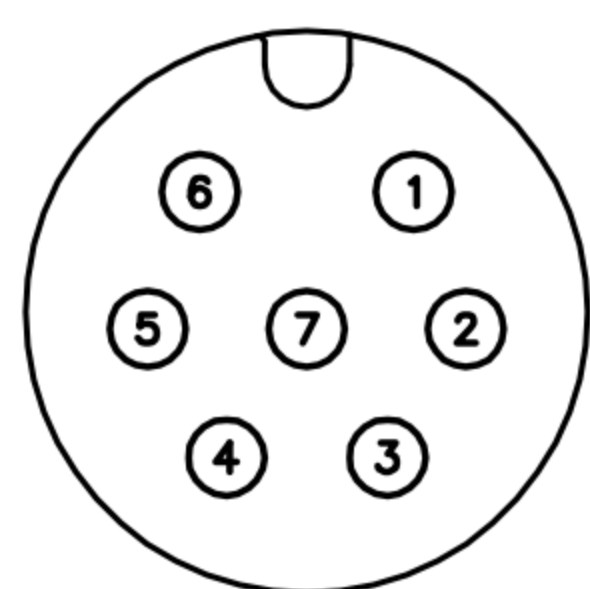

WP-07F2-13-11

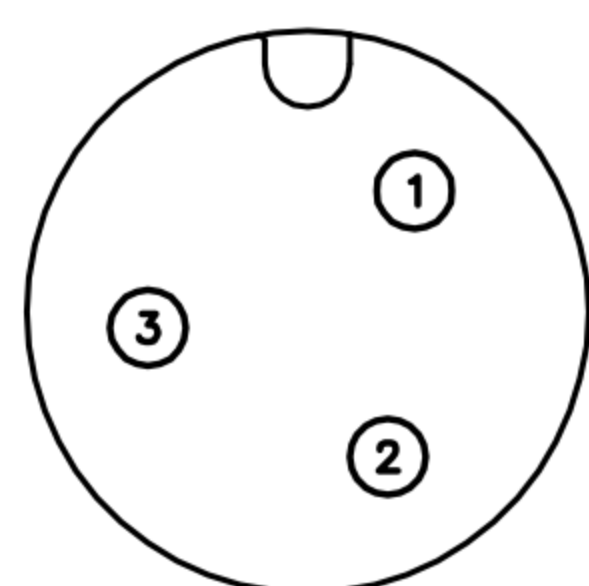

3P

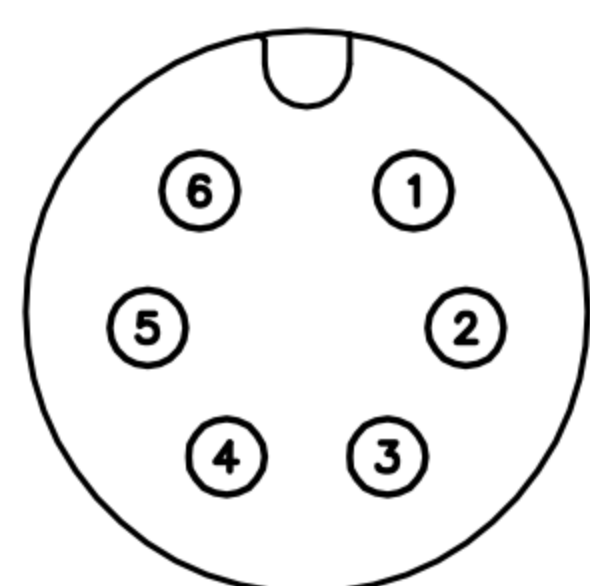

6P

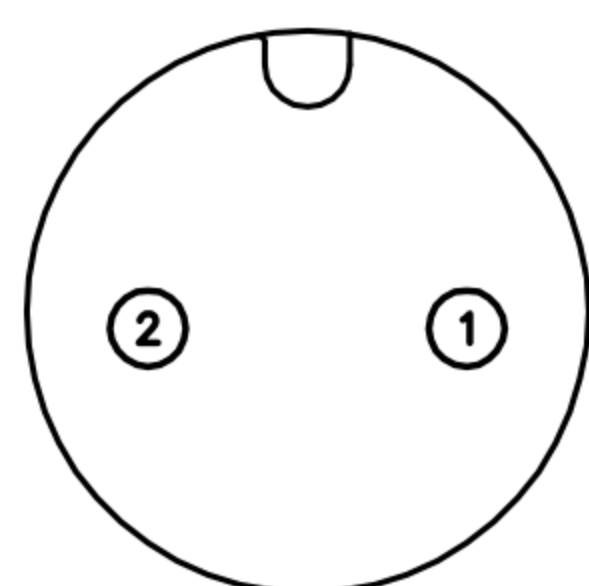

2P

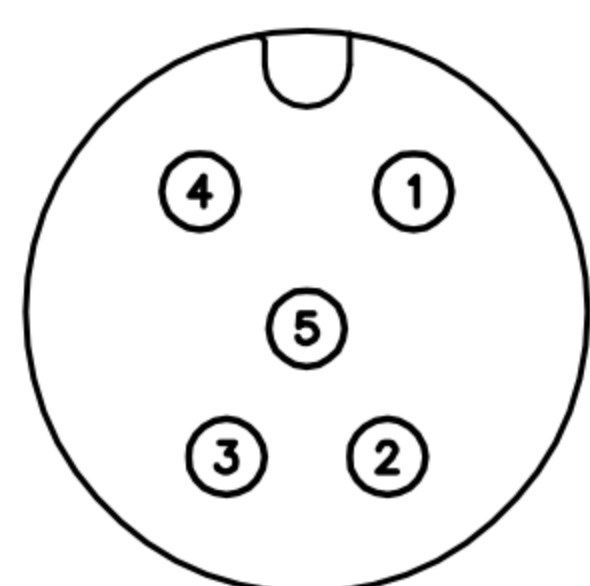

WP-05F2-161-11

Pin Assignments
Front View

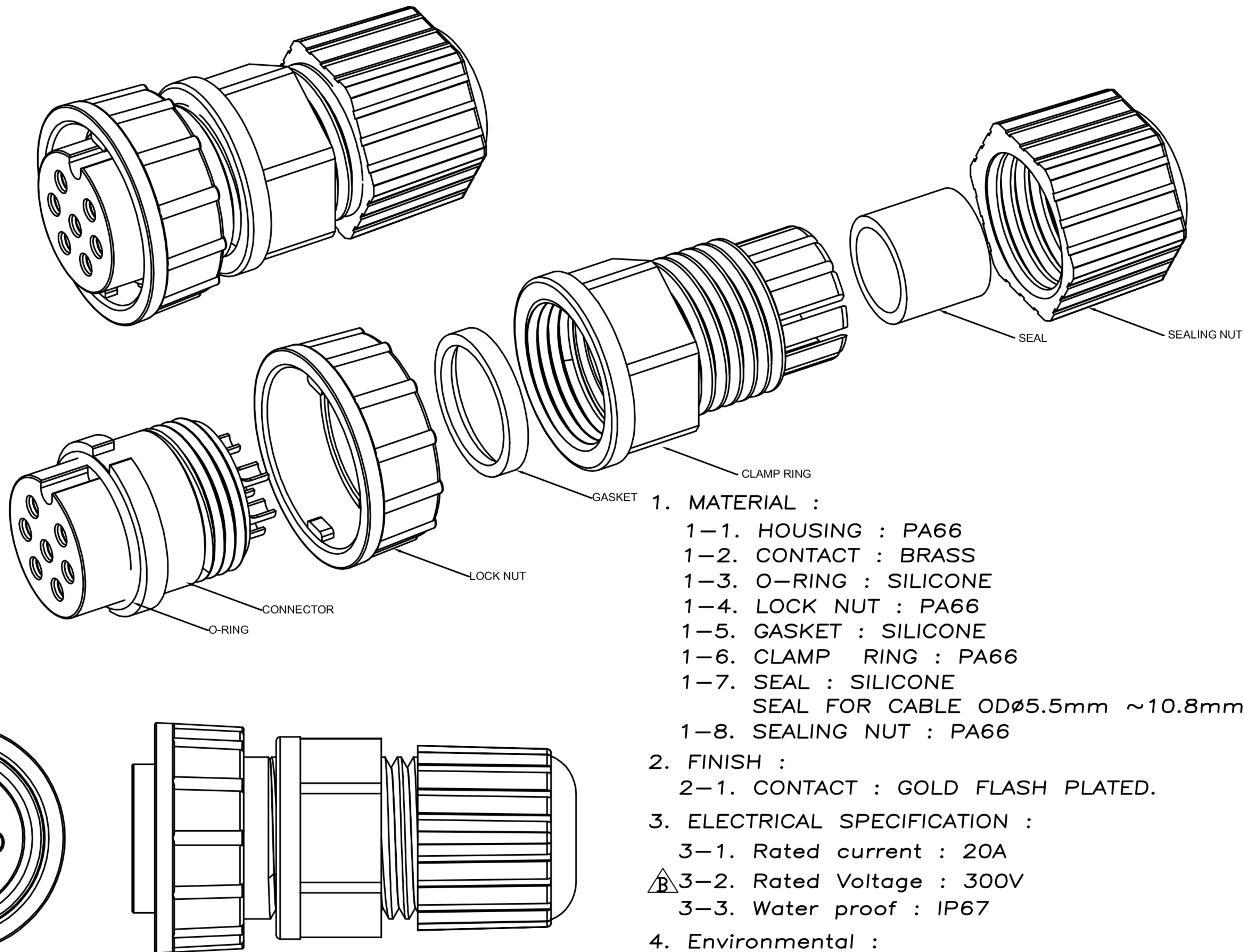
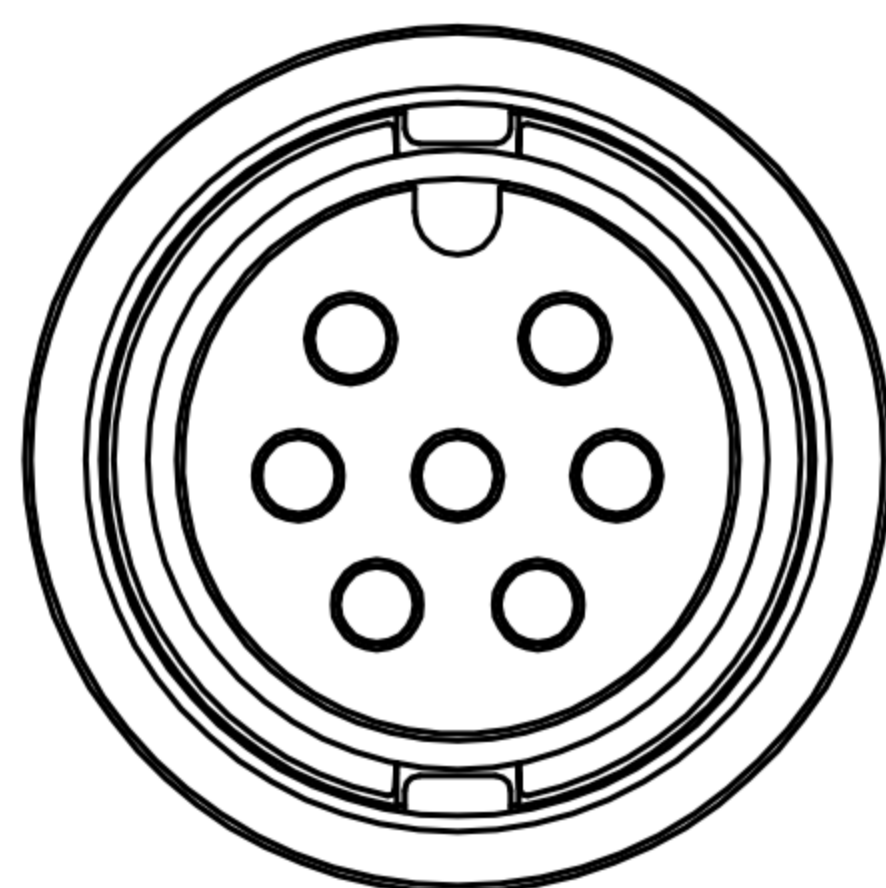

1. MATERIAL :

- 1-1. HOUSING : PA66
- 1-2. CONTACT : BRASS
- 1-3. O-RING : SILICONE
- 1-4. LOCK NUT : PA66
- 1-5. GASKET : SILICONE
- 1-6. CLAMP RING : PA66
- 1-7. SEAL : SILICONE
SEAL FOR CABLE OD ϕ 5.5mm ~10.8mm
- 1-8. SEALING NUT : PA66

2. FINISH :

- 2-1. CONTACT : GOLD FLASH PLATED.

3. ELECTRICAL SPECIFICATION :

- 3-1. Rated current : 20A
- △B 3-2. Rated Voltage : 300V
- 3-3. Water proof : IP67

4. Environmental :

- 4-1. Operation Temperature : -40 $^{\circ}$ C~105 $^{\circ}$ C

DRAWN	Emily Suen	APP'D	Ku Chou	UNIT	mm	TOLERANCE			TITLE	WP FEMALE (FEMALE PIN) D SIZE ASSEMBLY TYPE(LOCK)-20A			SHEET
CHK'D	Ku Chou			SCALE	1:1	.x ± 0.20 .xx ± 0.10 .xxx ± 0.05 .xxxx ± 0.03 ANGULAR $\pm 1^{\circ}$			PART NO.	SEE TABLE A	DWG NO.	QC8836	VERSION