

Flat(F)

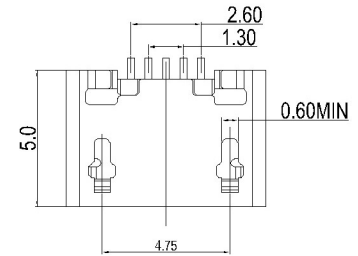

Scrolls (S)

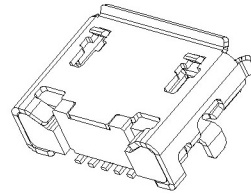
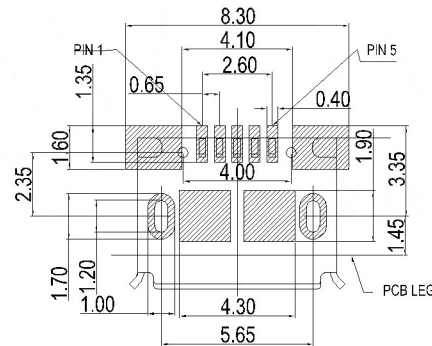
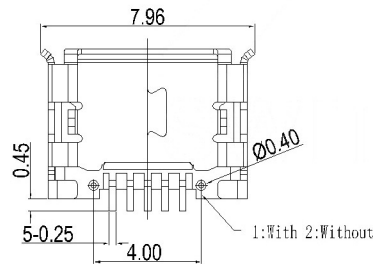
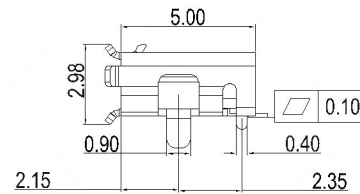
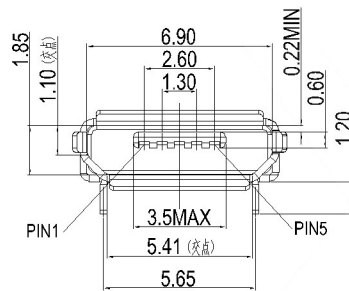

RECOMMENDED P.C.B. LAYOUT  
TOP VIEW (TOLERANCE: ±0.05)

Material  
Housing Material: LCP, UL94V-0, black  
Contact Terminal: Copper Alloy  
Metallic Shell: Sus  
Electrical  
Voltage Rating: 30 V AC  
Current Rating: Signal (Pins 2,3,4): 1.0A, Power (Pins 1,5): 1.8A  
Contact Resistance: 30mΩ Max  
Insulation resistance: 1000MΩ Min  
Dielectric withstanding voltage: 250V AC/Minute  
Mechanical  
Durability: 10,000 cycles  
Mating Force: 35N (3.57Kgf) Max  
Unmating Force: 8N (0.82Kgf) Min.

U254-05XX-4BH83-X-X-S

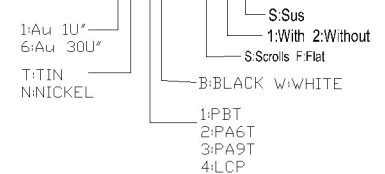

					ANGULAR	±5°
△X					L ≤ 4	±0.2
△X					4 < L ≤ 16	±0.3
△X					16 < L ≤ 63	±0.4
MARK	DESCRIPTION	DATE	REVISED	APPROVED	L > 63	±0.5
REVISIONS						UNSPECIFIED TOLERANCES
www.bodongkaiguan.net		www.ksdkg.com				

DSND		DATE		SCALE: N/A	MODEL TYPE: MICRO USB	
DWN		DATE		VIEW:	PART NO.: U254-05XX-4BH83	
CHKD		DATE		UNIT: mm	DWG NO.: U254-05XX-4BH83-XXS	
APPD		DATE		SIZE: A4		
Kosod Technology Co., Ltd.				WEIGHT	SHEET	REVISION
				1.0g	1/1	A0